

NS/fk

U. S. NAVAL TECHNICAL MISSION TO JAPAN  
CARE OF FLEET POST OFFICE  
SAN FRANCISCO, CALIFORNIA

3 January 1946

RESTRICTED

From: Chief, Naval Technical Mission to Japan.  
To : Chief of Naval Operations.

Subject: Target Report - Countermeasures and Defensive Organization  
of Japanese against U.S. Mines.

Reference: (a) "Intelligence Targets Japan" (DNI) of 4 Sept. 1945.

1. Subject report, covering Target O-03 of Fascicle O-1 of  
reference (a), is submitted herewith.
2. The investigation of the target and the target report were  
accomplished by Ensign M. O. Thompson, USNR, and Ensign A. D. Stone, USNR.



C. G. GRIMES  
Captain, USN

RESTRICTED

O-03

**COUNTERMEASURES AND DEFENSIVE ORGANIZATION  
OF JAPANESE AGAINST U.S. MINES**

**"INTELLIGENCE TARGETS JAPAN" (DNI) OF 4 SEPT. 1945**

**FASCICLE O-1, TARGET O-03**

**JANUARY 1946**

**U.S. NAVAL TECHNICAL MISSION TO JAPAN**

# SUMMARY

## ORDNANCE TARGETS

### JAPANESE COUNTERMEASURES AND DEFENSIVE ORGANIZATION AGAINST U.S. MINES

A study of Japanese defense against U.S. mines shows that pre-war Japanese techniques were outmoded by new types of U.S. mines, and that little preparation had been made in this direction during the early and middle phases of the war. Consequently, the Japanese were unprepared for the large scale mining of Japanese waters by U.S. aircraft. From the beginning of the mining operations to the end of the war, a great deal of study and research were devoted to methods of defense. Though little of the research had progressed beyond the experimental stage, it is believed that the Japanese ideas were good and that inadequacies of developments were due to lack of material and poorly trained personnel.

# TABLE OF CONTENTS

Summary .....	Page	1
List of Enclosures .....	Page	2
List of Illustrations .....	Page	3
References .....	Page	4
Introduction .....	Page	5
The Report		
Part I Japanese Magnetic Minesweeping Techniques .....	Page	7
Part II Acoustic Minesweeping Gear .....	Page	11
Part III Actuation Data for Japanese Mines .....	Page	13
Part IV Purpose and Use of Mark 3 and Mark 4 Sound Bombs .....	Page	15
Part V Japanese Method of Sweeping U.S. Mark 25, Model 1 Mines .....	Page	15
Part VI Japanese Method of Sweeping U.S. Mark 25, Model 2 Mines .....	Page	15
Part VII Japanese Methods of Sweeping Magnetic and Acoustic Mines .....	Page	15
Part VIII Moored Mine Sweeping .....	Page	15
Part IX Actual Japanese Minesweeping Operations .....	Page	15
Part X Japanese Operational and Technical Defense Against U.S. Mining Campaign .....	Page	17
Part XI Japanese Practice in the Diversion of Shipping Following a Mining Raid and Notification to Ships of Mined Waters .....	Page	23
Part XII Japanese Defense Tactics Against Aerial Mining .....	Page	25
Part XIII Why Barrage Ballons Were Not Used .....	Page	20
Part XIV Mine Disposal Techniques .....	Page	26
Part XV "Self-propelled" Soundmaking device .....	Page	28

## LIST OF ENCLOSURES

(A) Japanese Handbook for Magnetic and Acoustic Mines and Sweeps Part 2 (Translation) .....	Page	29
(B) Principal Items of Japanese Naval Sweeps .....	Page	41
(C) Type 3 Sweep Gear, Model 2 .....	Page	73
(D) Temporarily Designated Type 4 Sweep Gear .....	Page	74
(E) Type 2 Sweep Gear, Model 1 .....	Page	75
(F) Mark 4 Sound Bomb .....	Page	76
(G) Chart Showing Number and Types of Japanese Vessels Used During the War for Sweeping Operations .....	Page	77
(H) Japanese Report on U.S. Mines Swept -- 15 November 1945 .....	Page	81
(I) Chart Showing Damage to Ships Classified as to Cause of Damage, April through July, 1945 .....	Page	82
(J) Map Showing Mines Located at SHIMONOSEKI Straits with Mark "RA" Location Gear .....	Page	83
(K) List of Japanese Documents Forwarded via ATIS to WDC .....	Page	84

## LIST OF ILLUSTRATIONS

Figure 1	Three Methods of Towing Type 3 Sweep Gear .....	Page 7
Figure 2	Magnetic Sweeping Gear Type 5 .....	Page 9
Figure 3	Magnetic Sweeping Gear Type 2 Model 2 .....	Page 10
Figure 4	Temporarily Designated Mark 4 Sonic Bomb .....	Page 12
Figure 5	Fessenden Vibrator .....	Page 14
Figure 6	Skeleton View of "Fessenden Vibrator" Used as an Acoustic Mine Sweep .....	Page 14
Figure 7	Mark "RA" Locator .....	Page 21
Figure 8	Mine Detector Gear, Mark "RA" .....	Page 22
Figure 9	Light Submarine Detection Gear .....	Page 24
Figure 10	Devices for Marking Shipping Lanes Around Mined Areas .....	Page 25
Figure 11	Diagrams of Firing Mechanism in U.S. Mines .....	Page 26
Figure 1(A)	Magnetic Sweep Formations and Cable Data .....	Page 33
Figure 2(A)	Magnetic Rod Sweeper Used in Model 2 Type 3 Sweep Gear .....	Page 34
Figure 3(A)	Type 4 Sweeping Device .....	Page 36
Figure 4(A)	Type 4 Sweeping Device .....	Page 37
Figure 5(A)	Types of Noise Emitting Missiles .....	Page 39
Figure 6(A)	Acoustic Mine Sweeping Devices .....	Page 40
Figure 1(B)	Small Sweep, Model 1 Modification 1 .....	Page 42
Figure 2(B)	Single Ship Sweeping Gear .....	Page 44
Figure 3(B)	Twin Ship Large Sweeping Gear, Model 1 .....	Page 44
Figure 4(B)	Twin Ship Large Sweeping Gear, Model 2 .....	Page 48
Figure 5(B)	Twin Ship Large Sweeping Gear, Model 3 .....	Page 48
Figure 6(B)	Twin Ship Large Sweeping Gear, Model 4 .....	Page 51
Figure 7(B)	Twin Ship Large Sweeping Gear, Model 5 .....	Page 51
Figure 8(B)	Twin Ship Large Sweeping Gear for Shallow Water .....	Page 54
Figure 9(B)	Sweep, Type 2, Model 1 .....	Page 54
Figure 10(B)	Sweep, Type 3, Model 2 .....	Page 56
Figure 11(B)	Sweep, Type 5 .....	Page 56
Figure 12(B)	Mark 4 Sound Projectile .....	Page 59
Figure 13(B)	Sea Bottom Sweeping Gear, Model 1 .....	Page 59
Figure 14(B)	Underwater Disposal Device, Model 1 .....	Page 61
Figure 15(B)	Explosive Hook, Mark 2, Model 1 .....	Page 61
Figure 16(B)	Deep Sea Search Gear, Model 1 .....	Page 63
Figure 17(B)	Submerged Electric Line Cutting Gear .....	Page 63
Figure 18(B)	Large Paravane .....	Page 65
Figure 19(B)	Medium Paravane, Model 1 .....	Page 65
Figure 20(B)	Light Paravane Gear .....	Page 68
Figure 21(B)	Sweeping Markers .....	Page 68
Figure 22(B)	Sweeping Marker Lights .....	Page 71

## REFERENCES

### Personnel Who Assisted in Gathering Documents:

Lieut. T. Peake, USNR.

### Japanese Personnel Interviewed:

Captain KUNOKI, Chief of Minesweeping Operations (under U.S. direction since the end of the war).

Commander MATSUEDA, member of the Second Section, Second Division of the Technical Department in the Navy Ministry; specialized in mines, depth charges, and suicide squad operations.

Lieut. Commander M. HIGUCHI, Technical Department, Navy Ministry; specialized in Japanese mines and familiar with minesweeps.

Lieut. Colonel J. ISHIKAWA, Officer in Charge Experimental Station (a branch of Seventh Military Laboratories); specialized in Japanese acoustic location gear.

Lieut. Commander NUMATA, retired, formerly in charge of research on mine-laying submarines, Yokosuka Research Laboratory.

Major Y. IKITTA, technician at Second Military Research Laboratory, specialized in acoustic research.

# INTRODUCTION

This report is based upon documents, some of which are included as enclosures, and interviews with Japanese connected with minesweeping operations and the development of minesweeping gear.

Some of the information included in the report is related only indirectly to the subject under investigation but it is considered to be of interest and importance.

# THE REPORT

## Part I JAPANESE MAGNETIC MINESWEEPING TECHNIQUES

The Japanese employed two basic devices for sweeping magnetic mines; (a) the Type 3 or magnetic bar sweep and (b) tandem sweeps or those incorporating a magnetic tail.

### A. Type 3 (Magnetic Bar Type)

The Type 3 was a copy of the British Mark 1 captured at Singapore. The Japanese referred to the original design as the Type 3 Model 1. Methods of towing and adapting varied with the naval bases. Each naval base had an area to sweep and was responsible for adapting the sweep to its needs. Examples are shown in Figure 1.

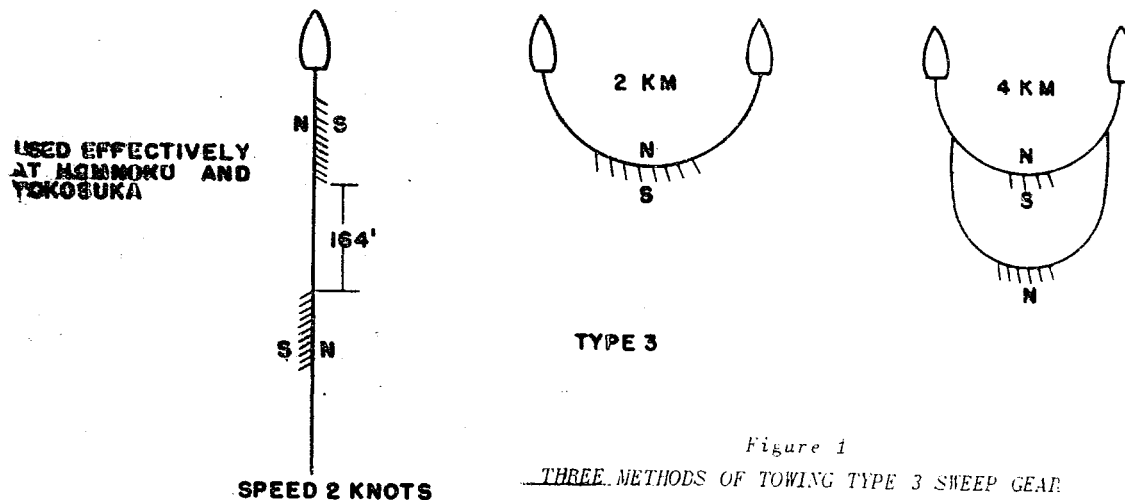

The effectiveness of Type 3 gear ranged from two to five meters (6.56 to 16.4 feet) varying with the type of mine swept. The sweeping speed, depending upon type of tow and mine, varied from two to six knots. Data on sweeping speeds and effective ranges for various mines are given in Table I of Enclosure A.

The sweep gear generally was secured to the hull of the ship, because securing to the deck was difficult and made streaming dangerous. The entire gear assembly weighed approximately one ton, a single bar magnet weighed eight kilograms (17.4 pounds). This gear was reported to be difficult to recover in more than 30 meters (98.4 feet) of water. The Japanese claimed that it was most effective when used from a single ship.

In an improved model, designated Type 3 Model 2 (See Enclosure (C)), the sweeping capacity was increased by attaching magnetic bars to magnetized cables, thereby extending the effective length of the bar from 80cm (2.62 feet) to eight or nine meters (26.2 to 29.5 feet). The magnetic cable was either a single cable an inch in diameter and five to ten meters (16.4 to 32.8 feet) long, or an equal length of several strands of small cable (surface area exceeded that of single cable).



The cable was magnetized with a cylindrical solenoid. While the coil was energized with direct current, the cable was drawn through it at a rate of less than three feet per second. The procedure was repeated at least three times.

The solenoid, wound on a cylinder of metal or bamboo, was slightly larger than the cable to be magnetized. Direct current from a storage battery built the field strength within the coil to 150 gauss, or more. The polarity of the cable was controlled by the direction of current flow through the solenoid. A 14-day test in rough water showed the loss of magnetism in the cable to be negligible. Ten days of effective sweeping could be guaranteed.

There was also a modified type which made use of the cables without bars.

Detailed information on construction, dimensions and method of streaming is given in Enclosures (A), (B), and (C).

#### B. Magnetic Tail Types

##### 1. Type 4 Sweeping Device (See Enclosure (D))

This sweep consisted of a moored cable loop capable of conducting direct current and a local power unit. The source of power could be located on land or aboard a moored ship. The sweep was developed to dispose of magnetic mines and to keep channels and anchorages open to shipping at all times. The effective area of disposal was dependent upon the amount of waterproof wire and the supply of direct current available in that area. The effective limits may be obtained from the nomograph which accompanies the third sketch in Enclosure A.

The transmission of current was controlled by a double throw, hand-operated switch at the source of the power supply. The Japanese determined that it was necessary to transmit current in one direction for at least three seconds and that generally it was necessary to reverse the direction of flow every 15 seconds. Furthermore, they believed that the maximum setting of the ships counter was 10 seconds with a dead period of six seconds. Therefore, it was necessary to send the current through the circuit at intervals over a long period of time.

##### 2. Type 5 Sweeping Device

This sweeping device was towed by means of three ships, one special duty wooden sub-chaser and two large landing barges. The source of power was a six kilowatt generator capable of producing a current of 55 amperes. The effective limit was ten meters (32.8 feet) above or below the cable.

The sweep was installed as shown in Figure 2. A wire coupling grip was attached to each buoy and a fixed depth was maintained by means of a plummet cord and buoy. The electrical circuit through the sweeping cable also is shown in Figure 2.

The effective depth of sweep was about ten meters (32.8 feet) as previously stated, and the effective breadth about 80 meters (262.4 feet). When the performance of the generator was good, the 60 meter (65.6 yards) cable could be lengthened and the sweep path broadened. It was advantageous to make the swept path as wide as possible by narrowing the distance from the front to the rear of the sweep. As this distance was decreased, the interval between pulses also had to be decreased.

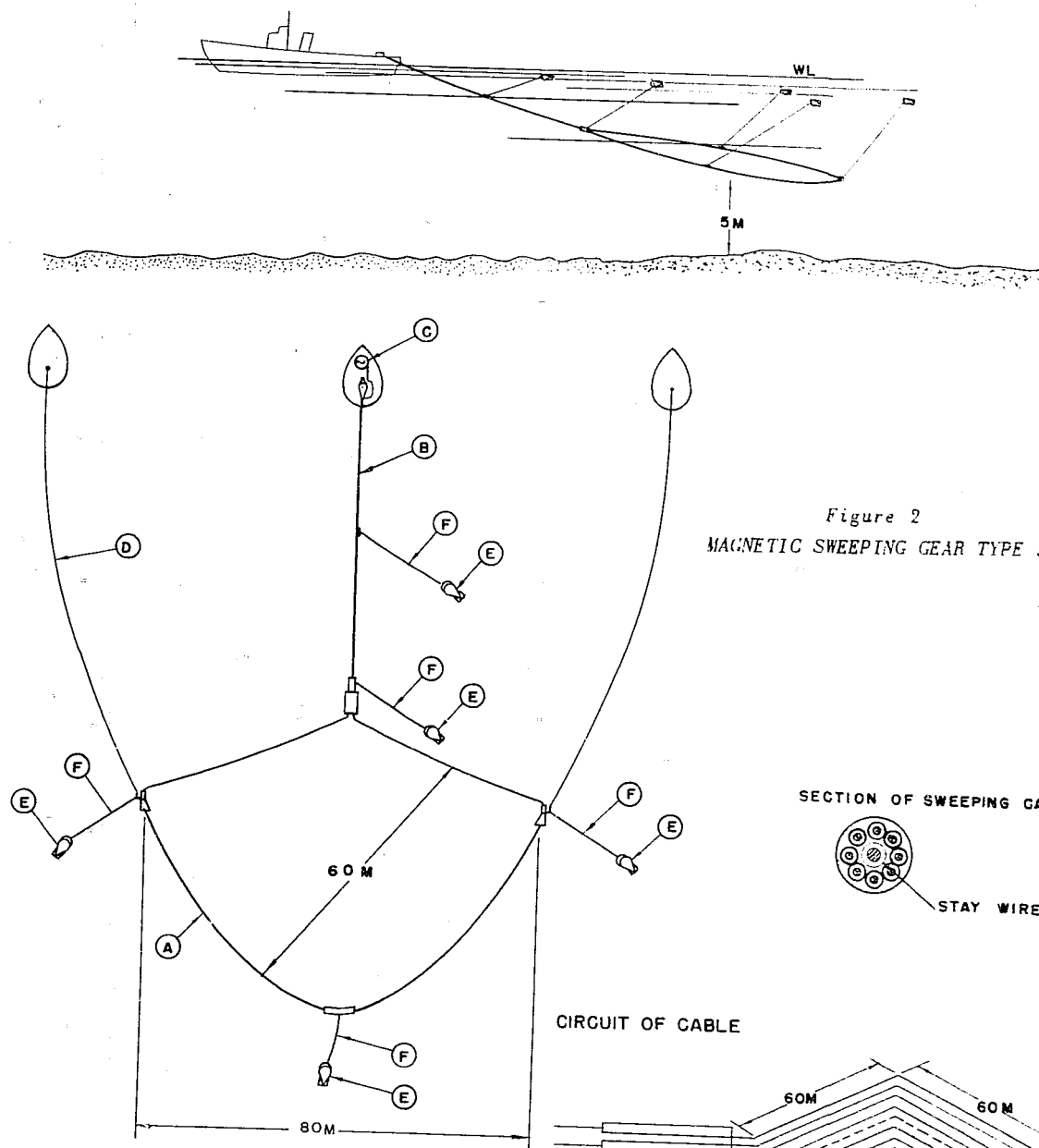
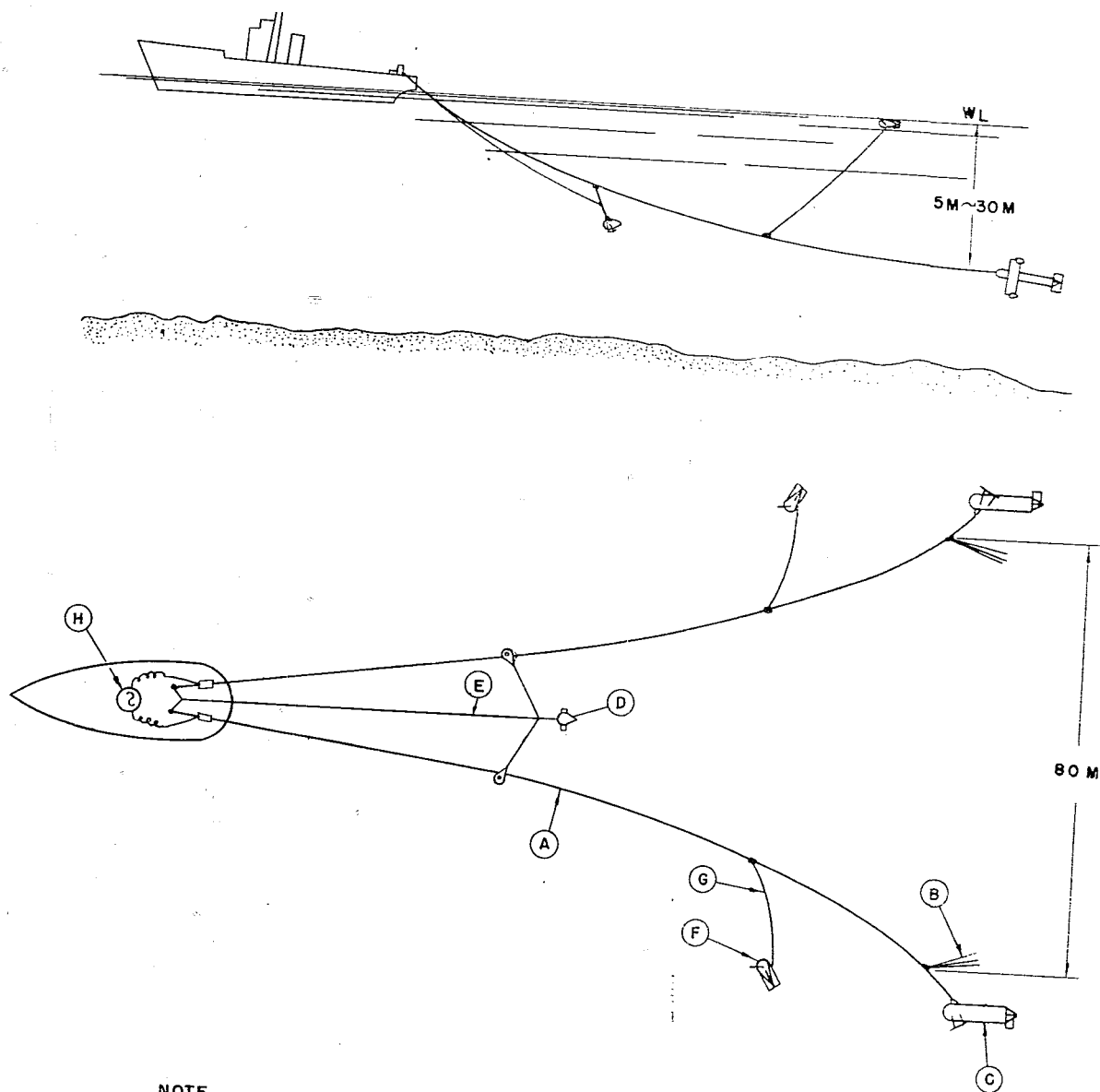

Figure 2  
MAGNETIC SWEEPING GEAR TYPE 5

NOTE

- (A) Sweeping Cable (Dia. 28mm Total Length 370m)
- (B) Dynamo
- (C) Towing Rope (Dia. 8mm Length 200m)
- (D) 60 KG Buoy For Separating The Sweeping Cable From Bottom
- (E) Buoy Rope For Depth Setting Sweeping Cable (Dia. 6mm Length 10m X 3)
- (F)



## NOTE

- (A) SWEEPING CABLE (DIA.36MM LENGTH 180M)
- (B) WIRE GROUNDED UNDER SEA-WATER
- (C) PARAVANE (DEPTH SETTING 5M-30M)
- (D) DEPRESSOR
- (E) TOWING ROPE (DIA.18MM LENGTH 60-70M)
- (F) 60KG BUOY FOR SEPARATING SWEEPING CABLE FROM BOTTOM
- (G) BUOY ROPE WHICH IS ADJUSTED ACCORDING TO THE DEPTH OF THE PARAVANE
- (H) DYNAMO

Figure 3  
MAGNETIC SWEEPING GEAR TYPE 2 MODEL 2

### 3. Type 2 Sweeping Devices

The Mine Research Laboratory at the Yokosuka Navy Yard designed two Type 2 sweeps.

Type 2 Model 1 was streamed from two ships. (See Enclosure (E).) It was an effective sweep, but was little used, because it required a large 40 kw generator capable of driving 180 amperes through the sweep cable. This gear could sweep a path of 300 meters (326 yards) with 710 meters (776.2 yards) of specially constructed cable.

Type 2 Model 2 was trawled by only one ship. (See Figure 3.) The components were a depressor with towing rope, and two magnetic sweep cables with floats, paravanes, and magnetic tails. Its operation was simple, the mines being swept by the magnetic field produced between the two magnetic tails.

For information on other magnetic sweeps of less importance see Enclosures (A) and (B).

Experiments were conducted at the beginning of the war on a sweep resembling the "Sperrbrecher". Although similar to the "Sperrbrecher" it was not a copy. Plans provided for the use of a coil of 100,000 ampere turns, which would produce a field of 30 milligauss about 50 meter (54.6 yards) ahead of the ship. This device was never used because the Japanese lacked the copper necessary to build the coil.

## Part II ACOUSTIC MINESWEEPING GEAR

The best acoustic sweeping method used by the Japanese was a combination of the Type F (Fessenden) and noise emitting missiles (Hotsuondan) or sound bombs.

Experiments were conducted on several designs of steam ejecting sound devices and on what was called a "drum beating" type sweep. These various types are discussed briefly in the following paragraphs and additional information is contained in Enclosures (A) and (B).

### A. Noise Emitting Missiles (Hotsuondan)

When the Japanese discovered that the Germans were using sound bombs to sweep acoustic mines, the Mine Research Laboratory at YOKOSUKA adapted sound bombs for the same purpose. After conducting experiments with sound bombs Marks 1, 2, and 3, it was found that the Mark 3 was the most satisfactory. These depth bombs were used originally as miniature depth charges in anti-submarine training when Japanese submarines were used as targets. The Mark 4 was found to possess a maximum effective range of 795 to 1000 meters (869.3 to 1090 yards). Within a small area near the dropping point the mines upon which the experiment was conducted were countermined. In experiments against mines sensitive to supersonic waves, it was found to be effective to about 33 meters (108.2 feet).

The Mark 3 was modified to become the Mark 4 by changing the case shape, and replacing the 100 grams of black powder with 300 grams of Type 38 explosive.

The Mark 4 sound bomb was prepared for launching by the removal of the friction piece, retaining pin and the removable strip (see Figure 4 and Enclosure (F)) around the sodium container. This strip proved a watertight seal in case of accidental launching.

Upon launching, sea water entered the sodium chamber through the flooding cocks and reacted with the sodium to produce large quantities of heat

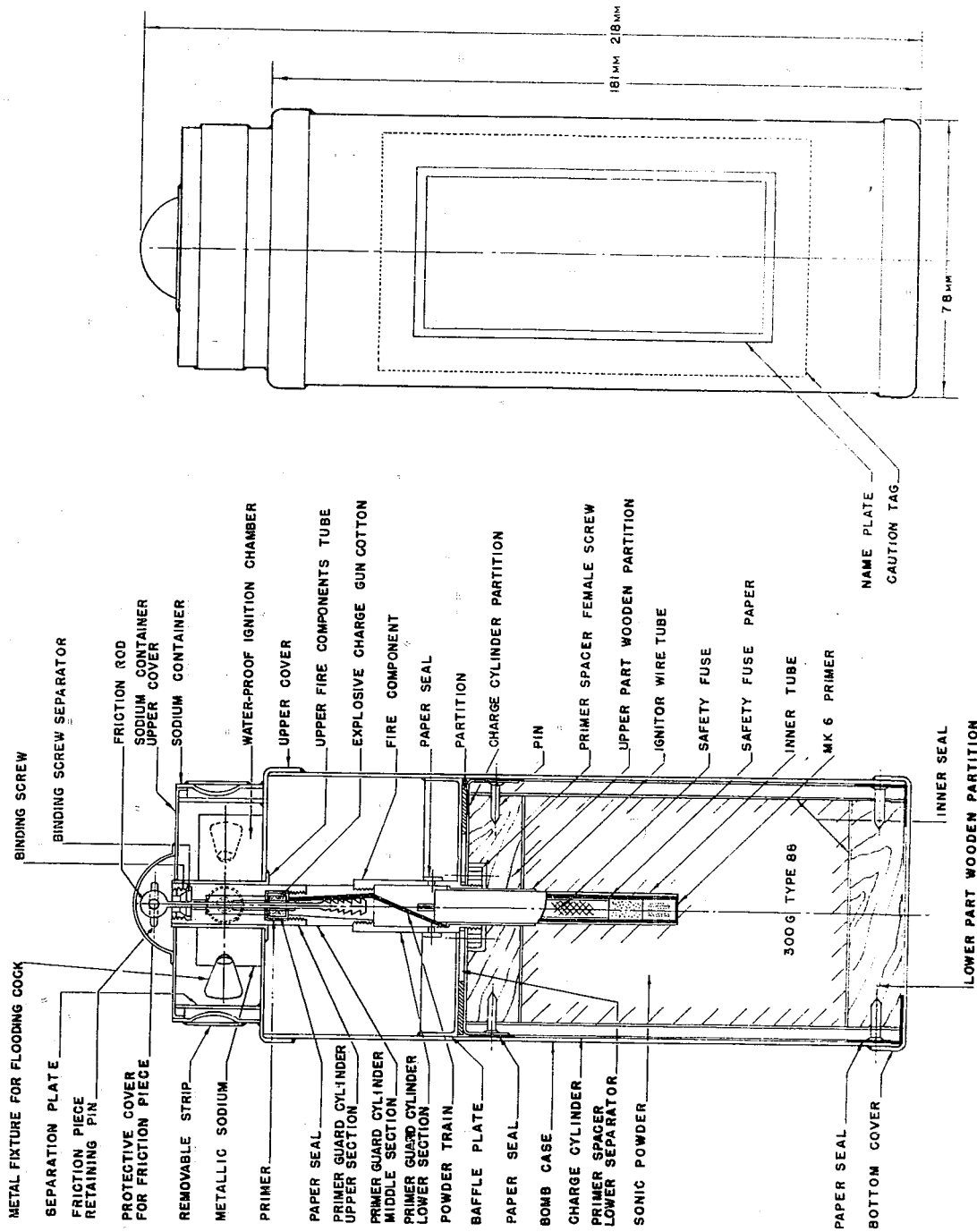

Figure 4  
TEMPORARILY DESIGNATED MK 4 SONIC BOMB

and hydrogen. The resulting rapid increase in pressure blew the cover from the sodium chamber, which in turn pulled the friction piece from the primer tube. As the friction piece was pulled outward, the serrations on its lower end ignited a match composition near the small explosive charge of gun cotton. This in turn ignited the gun cotton which ignited a powder train leading to the retarder. Within the retarder a satisfactory delay was incorporated, which allowed the sweeping ship to get safely away.

The most effective sweeping speed was found to be three knots. At this speed the swept mine would fire about 300 meters (326 yards) from the ship. As protection against duds, the bombs were dropped in pairs. A single sweep, consisting of five pairs dropped at two second intervals, was made every 145 meters (158.5 yards). This maneuver gave nearly continuous sound for 10 seconds, every 145 meters (158.5 yards).

Later, the Mark 5 noise emitting missile was developed to take the place of a single sweep of Mark 4 sound bombs, thus simplifying operations and giving more accurate timing of explosions.

The Mark 5 incorporated the same firing device as the Mark 4. The 300 grams of Type 88 explosive around the retarder of the Mark 4, however, was replaced by five cylindrical containers, each containing 50 grams of Type 88, and these cylinders were soldered to the main retarder. This entire assembly was placed in a light, tin plate case. When the main retarder fired, it ignited the retarders of the various units. These retarders had time delays which differed by half a second, thus giving a nearly continuous sound for 2.5 seconds.

The sweeping speed for the Mark 5 was the same as for the Mark 4, but the dropping interval was increased to 385 meters (420.9 yards).

#### B. Type F (Fessenden) Acoustic Minesweeping Gear

The Type F originally was used for submarine acoustic communication. In shape it resembled the U.S. sound box. The box consisted of two fixed permanent magnets, a fixed primary coil, and a copper cylinder secured to a vibrating blade (see Figure 5). The primary coil received alternating current from a two to three kilowatt motor generator. The magnetic field thus produced caused the copper tube to oscillate longitudinally. The vibrating blade, attached to the copper cylinder, also oscillated, producing sound waves at a frequency of 500 vibrations per second.

#### C. Miscellaneous Types

A number of experiments were being conducted on various other types of acoustic sweep gear.

One type which used high pressure steam ejected from nozzles in a steam pipe placed below the water surface was being developed. (See illustration in Enclosure (A).) It never was used because the wooden ships which were essential to successful sweeping operations could not generate enough steam.

Another type used a motor-driven piston which beat against two diaphragms secured near each end of the piston. (See illustration in Enclosure (A).) This drum beating method never was successful.

### Part III ACTUATION DATA FOR JAPANESE MINES

Refer to NavTechJap Report, "Japanese Mines", Index No. O-04, for actuation data concerning Japanese mines of all types, including those in design as well as those in production.

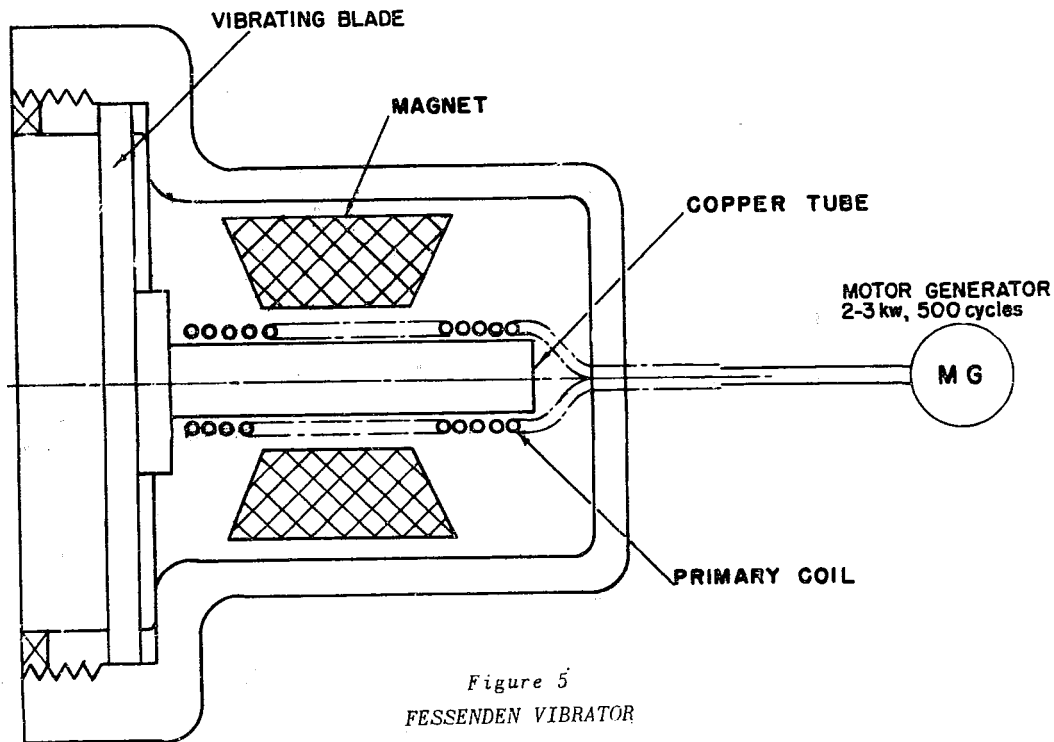

Figure 5  
FESSENDEN VIBRATOR

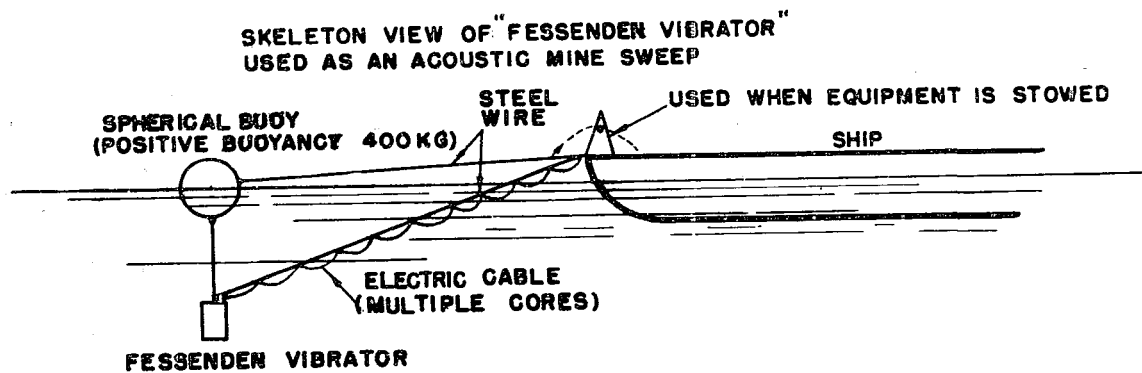

Figure 6  
SKELETON VIEW OF FESSENDEN VIBRATOR  
USED AS AN ACOUSTIC MINE SWEEP

Part IV  
PURPOSE AND USE OF MARK 3 AND MARK 4 SOUND BOMBS

The Mark 3 sound bomb was used for training purposes on destroyers making practice attacks on submarines. Its explosive charge was 1000 grams of black powder. The Germans informed the Japanese that they were using a sound bomb to sweep U.S. mines, so the Mark 3 was modified to the Mark 4 and used for sweeping. Its explosive charge was 300 grams of Type 88 explosive.

Part V  
JAPANESE METHOD OF SWEEPING U.S. MARK 25 MODEL 1 MINES

No method was completely developed for sweeping U.S. Mark 25 Model 1 mines. The Japanese attempted to countermine by producing low frequency sound. For this purpose the Fessenden was adapted to produce sound at frequencies of 50 and 100 vibrations per second. Experiments in August 1945 indicated that the intensity was not great enough to countermine, hence the mechanism was not installed.

The Japanese claim to have swept a few Mark 25 Model 1 mines with Mark 4 sound bomb.

Part VI  
JAPANESE METHOD OF SWEEPING U.S. MARK 25 MODEL 2 MINES

A successful method for sweeping the Mark 25 Model 2 mine never was developed. At NIIGATA, six of these mines were recovered by a drag net sweep, but this method was considered too dangerous and impractical.

Experiments were being conducted at the Kure Navy Yard on the use of a mine disposing vessel and a towed board causing water pressure. (See Enclosure (K) of NavTechJap Report, "Japanese Minesweeping Gear and Equipment", Index No. S-28.)

Part VII  
JAPANESE METHODS OF SWEEPING MAGNETIC AND ACOUSTIC MINES

Gear and methods used in sweeping magnetic and acoustic mines are discussed in Parts I and II of this report. See also Enclosures (A) and (B).

The general method used in explosive sweeping by aircraft was to fly 300 to 600 feet above the water and drop sound bombs, Marks 3, 4, and 5 over mined areas.

Part VIII  
MOORED MINESWEEPING

Moored minesweeping is discussed in Enclosure (B). All Japanese vessels engaged in sweeping operations during the war are listed in Enclosure (G).

Part IX  
ACTUAL JAPANESE MINESWEEPING OPERATIONS

Actual sweep records were burned at the time of the Japanese surrender. Since no overall organization for minesweeping existed, it would have been necessary to interrogate the commanders of the naval bases to determine definitely the actual minesweeping operations carried out in all Japanese waters. However, basic operations in the various areas appeared to have been similar and a report from one base may be considered representative of all bases. The following is a portion of a report submitted by Rear Admiral MATSUZAKI on operations in the OSAKA area.



"Minesweeping in OSAKA Area"(A) Minesweeping During the Early Period of Minelaying by United States Planes in OSAKA Area

(1) The magnetic minesweeping unit of the Kii Defense Garrison was advanced to OSAKA-Wan and engaged in sweeping. Strength:

Type 5 minesweepers - 2 units  
Type 3 Model 2 minesweepers - 3 units

(2) Minesweeping with sound bombs by planes of Komatsushima and Kushimoto Seaplane Bases was attempted. The minesweeping was done by a total of six planes on 4, 5, and 6 May. Total, number of mines swept - 15.

"(B) Minesweeping and Counter-measures After Above Period

The minesweeping units of the Kii Defense Garrison were stationed permanently at OSAKA and KOBE harbors and became the main strength in sweeping in channels where the mines were reported to have been laid.

"(C) Number of Mines Dropped and Mines Swept

(1) Number of times mines were dropped:

May	4 times	
June	7 times	
July	4 times	
August	3 times	(Reported)
Total	18 times	

(2) Estimated number of mines dropped - 500 to 600.

(3) Mines disposed of:

By Type 5 sweeping apparatus .....	24
By Type 3 improved style Minesweeping apparatus .....	13
By acoustic (Sound Bomb) Minesweeping apparatus (Includes 15 by use of planes) .....	70
By self or undetermined explosion .....	56
Total	163"

The following discussion of the problems encountered by the Japanese Seventh Fleet during the mining attack against the SHIMONOSEKI Straits area is contained in a report submitted by Capt. MINAMI.

"The Commander of the First Escort Fleet moved his headquarters from TAKAO, Formosa, to MOJI in February 1945, and in April he was assigned the additional responsibility of defending the SHIMONOSEKI Straits against mine attacks. In this capacity the First Escort Fleet was known as the Seventh Fleet although the same staff administered both activities.

"Due to the fact that the United States did not use mines extensively during the first years of the war, the Japanese allowed their research efforts to relax and consequently they were in no way prepared for the saturation type of attacks which were delivered in Japanese waters in the spring of 1945. The equipment available at SHIMONOSEKI was not only insufficient in quantity, but it was improperly designed.

"Frantic efforts were made to counter the mining of SHIMONOSEKI Straits which had a normal traffic of 1,250,000 tons per month, composed of 20 to 30 ships above 500 tons and 100 to 200 ships below 500 tons. An extensive system of mine watchers was immediately established by the Seventh Fleet. Watchers were stationed along the coast, in adjacent hills, and in numerous fishing boats anchored in various channels. Radar, searchlights, and underwater sound equipment were employed to assist in spotting the mines. In addition, a comprehensive research and counter-measure construction program was instituted and each major naval base in Japan was assigned a specific part of the counter-measure program.

"After each mining attack it was the policy to sweep from dawn to dusk in the observed area. Since it was the practice of the United States Air Force to mine the eastern and western entrances alternately, the attack could be anticipated and all equipment could be concentrated in the threatened area. If both entrances had been mined simultaneously, it would have been necessary to divide the sweeping equipment available.

"The mining of the strait itself caused considerable trouble because of currents which complicated sweeping and moved the mines, and because of the necessity of sweeping the entire strait completely in order that ships could move to moorings along the beach.

"After each offensive mining operation by American planes many mines were invariably recovered on the beach. On 27 May, 30 such mines were recovered, and it was at this time that the magnetic pressure type was discovered.

"At times the traffic in the straits became so jammed that it was necessary to force ships through, regardless of losses. Occasionally destroyers and submarines passed through the Straits. On 25 May one light cruiser and six destroyers proceeded through the Straits although it was not considered safe. One destroyer was hit and heavily damaged. Two submarines were sunk at a later date, and shortly after the war two destroyers were sunk while enroute to SASEBO.

"The number of premature explosions of American mines was puzzling and a research section was established to investigate the possible causes. No definite answer was arrived at, although it was noted that the number was greatly reduced during the last weeks of the war.

"Although night fighters were furnished by the Army for the defense of SHIMONOSEKI Straits, they were very ineffective. Anti-aircraft fire from escort vessels succeeded in destroying one B-29 on 27 May and one on 9 July."

The exact numbers and types of U.S. mines laid were of course not known by the Japanese, because mines dropped during raids often were unobserved or the types were not known. The record of swept mines is just as inaccurate. Enclosure (H), "Japanese Report of U.S. Mines Swept", is a chart prepared on 15 November 1945 showing the approximate number of U.S. mines laid and percentage swept.

Sweep gear and ships frequently were lost by mine explosions. However, casualties were light. See Enclosure (I) for approximate statistics.

#### Part X JAPANESE OPERATIONAL AND TECHNICAL DEFENSE AGAINST U.S. MINING CAMPAIGN

As a whole, the defense against the U.S. mining campaign was ineffective. Apparently the Japanese had given little thought to defense against mines, and they were entirely unprepared. The importance of some sort of defense soon was realized, however, and mine watches and means of information transmission were established.

At all important harbors civilian personnel were designated as mine watchmen and stationed at advantageous lookout positions along the shores. In addition, both the Army and Navy maintained watchmen stationed in small boats in the harbor. When a mine was observed by these watchmen, its position was noted and the information was sent to the nearest naval base as quickly as possible. Each base had a liaison officer who handled mine affairs. This officer made local radio broadcasts before sending information to the Bureau of Naval Affairs in TOKYO. From TOKYO the information was sent to all ships or organizations concerned.

It has been pointed out that there was no central minesweeping organization as such. Each Naval Base Commander was responsible for sweeping the mines from waters under his command. The following report submitted by Rear Admiral MATSUZAKI describes a typical local minesweeping organization. It is considered important since it effectively illustrates how unprepared the Japanese were, in organization and equipment, for large scale mine attacks.

"Counter-Measures Against Mines Laid by American Aircraft in OSAKA Area

"1. Counter-measures employed in view of the conditions of minelaying by the United States Aircraft in the KWANMON area.

"a. Establishment of magnetic minesweeping unit at Kii Defense Garrison (YURA). Order was issued to establish magnetic minesweeping unit on 5 April 1945. Preparations were begun immediately.

"b. Establishment of Osaka Port Defense Garrison and Kobe Port Defense Garrison. Order was issued on 1 May 1945 to establish initially the Osaka and Kobe Port Defense Garrisons. However, minesweeping strength could not be mobilized until the early part of June.

"c. Prepared for minesweeping by use of sound bombs from airplanes at Komatsushima and Kushimoto Seaplane Bases.

"d. Established look-out posts for mines along seashores of OSAKA-WAN, HARIMANADA, and AWAJISHIMA in the early part of April.

"e. Prepared a map as of 4 April 1945, showing the channels to be swept and thus prepared for counter-measures against mine laying.

"f. The strength of each minesweeping unit as of 4 May 1945 was as follows: (United States planes laid mines in OSAKA-WAN for the first time).

(1) Kii Defense Garrison

Type 5 minesweeper	
Mother boats (converted sub-chaser)	3
Side boats (fishing boat)	9
Type 3 Model 2 minesweepers (fishing boat)	10

(2) Osaka Port Defense Garrison; Kobe Port Defense

Garrison Strength	0
-------------------	---

(3) Komatsushima and Kushimoto Bases Scout Seaplanes 6

"g. The status of the strength of minesweeping units as of 11 June 1945 was:

(1) Minesweeping equipment

Name	Drag Net	Type 5 Mine Sweeper	Type 3 Model 2 Mine Sweeper	Reformed Type 3 Sweeping Equipment	Sound Bombs
Osaka Naval Munition Dept.		7 sets (no accessories)	11 sets, 940 magnetic bars		13,000
Kii Defense Garrison	10 (length 10cm, breadth 70cm, mesh: 6 sq ft. Manila hemp)	1 set (no accessories)	5 sets		800
Osaka Port Defense Garrison			10 sets		130
Kobe Port Defense Garrison		All equipment lost by fire	22 sets (only 17 sets usable)	18	300

(2) Mine sweeping vessels

Name	Type 5	Type 5 Model 2	Type F
Kii Defense Garrison	Mother boats 3 (converted sub chaser) Side boats 9	Fishing boats 10	
Osaka Port Defense Garrison		Fishing boats 10 Schooners 1	
Kobe Port Defense Garrison		Fishing boats 12 Schooners 1	

"h. Set up anti-mine lookout posts in early part of June at important points along the channels to be swept and endeavored to collect accurate information quickly.

"i. Planned to set up searchlights in the vicinity of AKASHI Seto.

"2. Navigation Control

"a. Put into effect navigation control in accordance with the conditions of minelaying and minesweeping.

Chief control station: Osaka Minor Naval Station

Other control stations: Osaka Naval Office of Resident Officers.  
Kobe Naval Office of Resident Officers.  
Kii Defense Garrison.

When bombing by United States planes became frequent, the time of movement of vessels to and from ports was controlled.

"b. As the damage due to bombing and mines increased and the navigation of vessels in general (steel) became actually impossible, impetus was given to the use of wooden vessels and schooners. In order to assure the safe sailing of these vessels, connecting bases were established in six localities: SAKAGASHI, IESHIMA, SHIMOTSU, TANABE, SUSAMI, URAQUAMI.

"c. In order to protect the sailing of vessels fairway-buoys were planted 2,000 meters (6560 ft) apart on one side (partly both sides) of important channels during the middle of July."

The Japanese used no suicide sweeping craft, although ships often were sent through unswept channels.

The Japanese Navy had no location ships or location gear. However, the Japanese Army modified the Navy's "Light Submarine Detection Gear" and called it the "Light Echo Ranging Equipment." This locator was better known as 'TANRAI-KI', meaning 'mine detector', or Mark 'RA'.

The Mark 'RA' detector, (see Figure 7), operated on the echo ranging principle. That is, signals were transmitted at short intervals and upon striking an object, such as a mine, the signals were reflected and returned to the transmitter, being registered as a mark on the recording paper.

Energy for transmission of sound signals was supplied by two 12-volt batteries capable of 120 ampere - hours. A converter increased the voltage to 2000 and charged a 10 microfarad condenser.

The keying system controlled the transmission of the sound waves. A cam synchronized with the recorder opened and closed the relay circuit. When this circuit was closed the energized coil became the electro-magnet, opening the relay switch. During the instant the cam opened the relay circuit, the coil lost its energy, released the relay switch, which was spring loaded upward, and closed the tank circuit. Magnetostriction of the Al-Fe core of coils in the transmitter caused a 14.5 kc sound to be emitted. The rate of transmission could be 45 or 90 times per minute, depending upon the RPM of the recorder.

The transmitter acted as both a transmitter and receiver. If the sound wave struck an object, such as a mine, it was returned. The transmitter received the returning signal which was passed through an amplifier and rectifier to the recorder. A helical ridge on the recorder drum made contact with the potassium iodide recording paper at all times. As the current produced by the signal passed through the paper a mark was made. The distance between this mark and the left edge of the paper represented the distance from the ship to the mine. The range of this sweep was 500 meters (1640 feet) when the recorder rotated at 90 RPM; at 45 RPM the range became 1,000 meters (3280 feet).

The Mark 'RA' was mounted on a landing boat with the transmitter suspended over the side amidships on a ball and socket joint (see Figure 8). The transmitter could be trained through 360° on a horizontal plane and 180° in a vertical plane.

Originally five ships were equipped with Mark 'RA' gear and they were used effectively in SHIMONOSEKI Straits in April 1945. See Enclosure (J) for map showing mines detected by the Mark 'RA' gear.

The following description of its operation was submitted by the Japanese: "Explanation of the Mine Detection Gear Mark 'RA'".

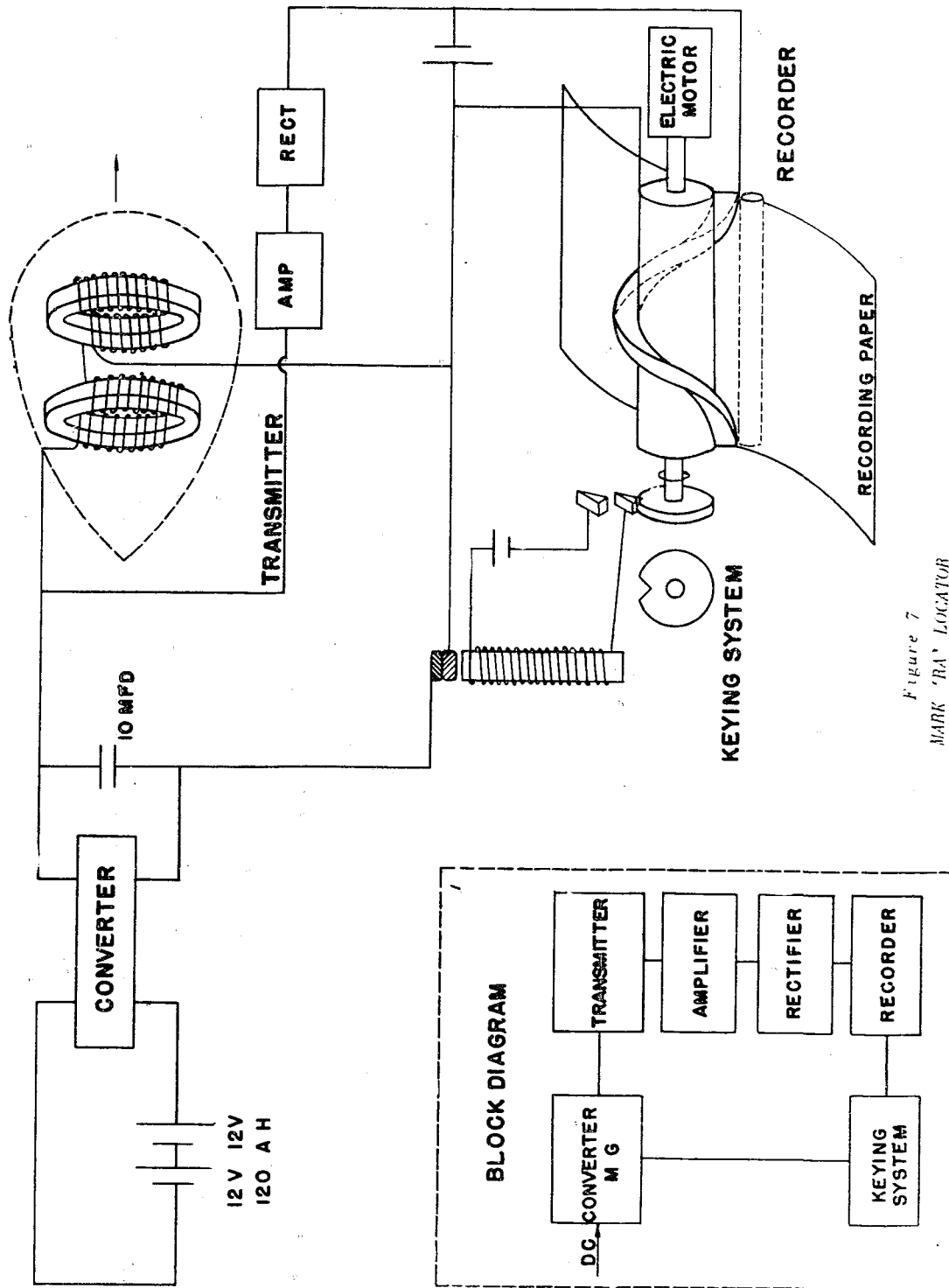

Figure 7  
MARK 'TRA' LOCATOR

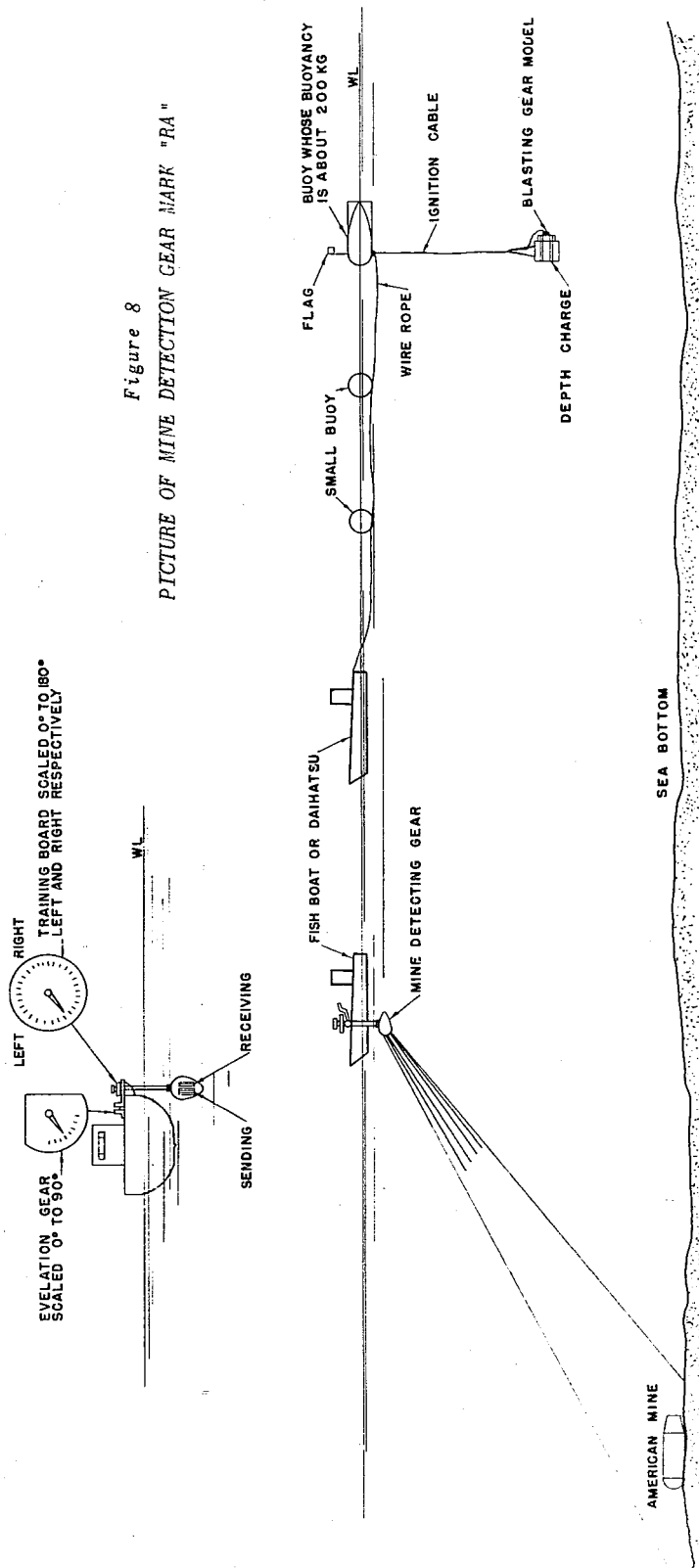

Figure 8  
PICTURE OF MINE DETECTION GEAR MARK "RA"

"The mine detection gear Mark 'RA' was developed by the Army by fitting an elevating device to the vibrator of a light submarine detection gear of Navy type so as to make the vibrator especially adaptable for mine detecting. Its acoustic character is not much different from the naval gear.

"The sound wave of 14.5 kc is sent toward the bottom of the sea from the vibrator fitted in a boat and the reflecting sound is recorded electrically on a special device in the same boat. There is a difference in the reflection intensity, between reflected sound from sea bottom and that from a mine, thus the dots electrically spotted on a recording paper vary in their color according to the difference of reflection intensity; the reflection from mines records darker marks on paper than reflection from the sea bottom.

"The recording paper is automatically wound around a drum in the recording instrument at a constant speed by a motor. In this instrument there is also a pen which turns around at a fixed speed different from that of the above mentioned drum, and touches lightly on the surface of the recording paper. When a reflection sound is received, the electrical circuit is closed between the pen and the paper and a dot is recorded. On the recording instrument a distance scale is fixed. By means of reading the relative position of a dot on this scale, we can determine the distance from the origin of each reflective sound.

"In order to find the direction of a mine we utilize the vibrator itself which sends out acoustic sound. Around the handle of the vibrator there is a direction scale. If we turn the vibrator by the handle exactly toward a mine, a dot is spotted very dark on the recording paper; and when this dark dot is marked, we read the direction on the direction scale. (See Figure 8.) It is to be noted that although the minimum depth detectable by this gear is not known, the Army detected mines in water five meters (16.4 feet) deep with this apparatus in SHIMONOSEKI Straits."

#### Part XI

#### JAPANESE PRACTICE IN THE DIVERSION OF SHIPPING FOLLOWING A MINING RAID AND NOTIFICATION TO SHIPS OF MINED WATERS

Whenever possible ships were diverted from mined areas to areas thought to be safe. However, at times traffic became so congested that ships were sent through mined waters regardless of the losses which might ensue. As mining operations increased, and the navigation of steel vessels became almost impossible, wooden schooners were used to transport war materials. For complete information see the report of Rear Admiral MATSUZAKI quoted in Part X.

To illustrate the effect of the mining campaign upon shipping, monthly data on movements of seagoing vessels at KOBE and OSAKA are given below:

#### MOVEMENTS OF SEAGOING VESSELS

Month	Number of Vessels			
	OSAKA Port		KOBE Port	
	Outgoing	Incoming	Outgoing	Incoming
May	109	77	60	54
June	29	20	21	11
July	53	41	15	16
August	12	10	9	10
September	20	19	1	2
October	6	6	0	0

(See also NavTechJap Report, "Evaluation of Effectiveness of Allied Offensive Mining Operations Against Japanese Shipping in Chinese and Southwest Pacific Waters", Index No. S-98(N).)



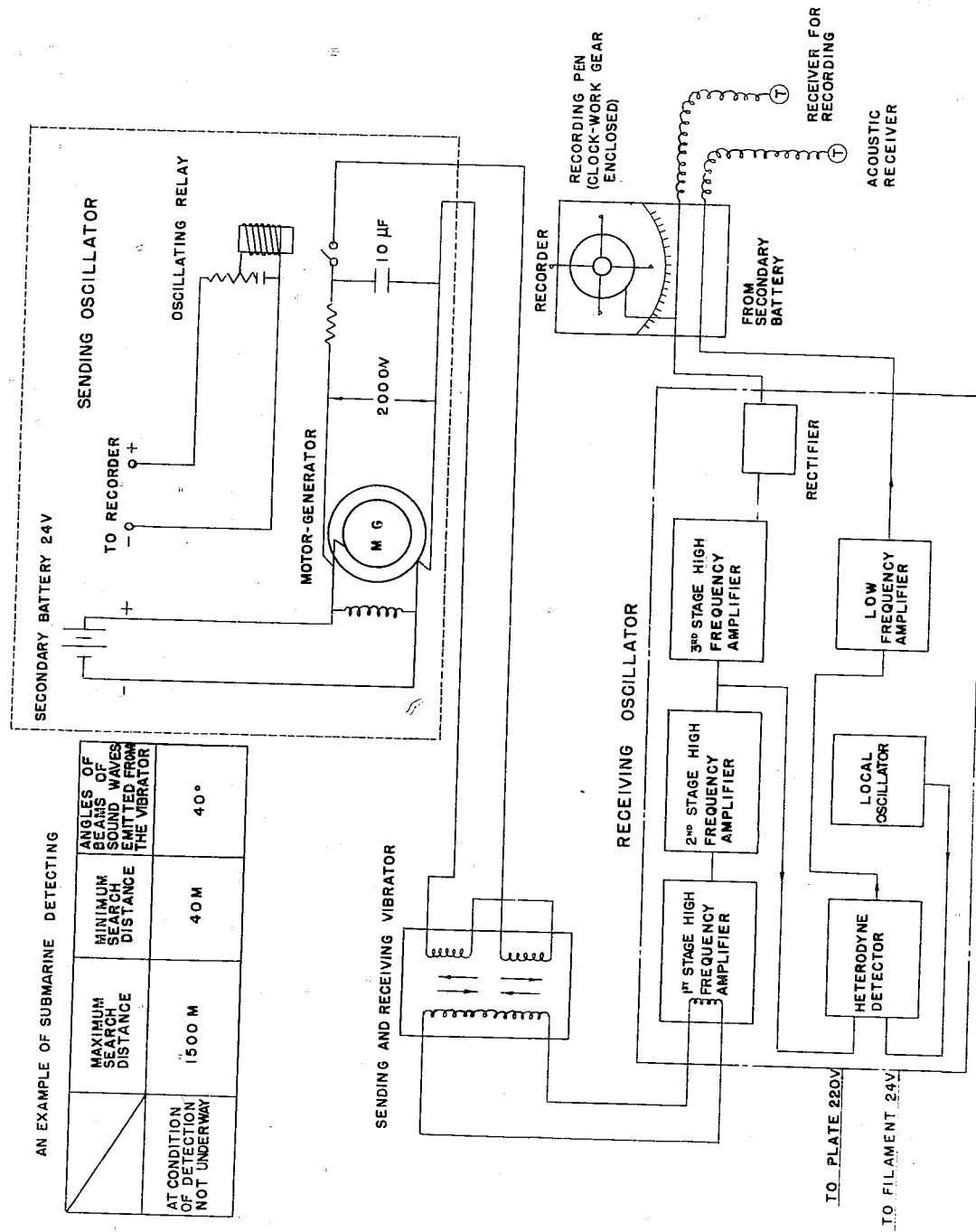

Figure 9  
LIGHT SUBMARINE DETECTING GEAR

Ships were notified of mined waters by Radio Tokyo, but mined areas were not marked. Shipping lanes were designated around mined areas and these lanes generally were marked by one of the devices shown in Figure 10.

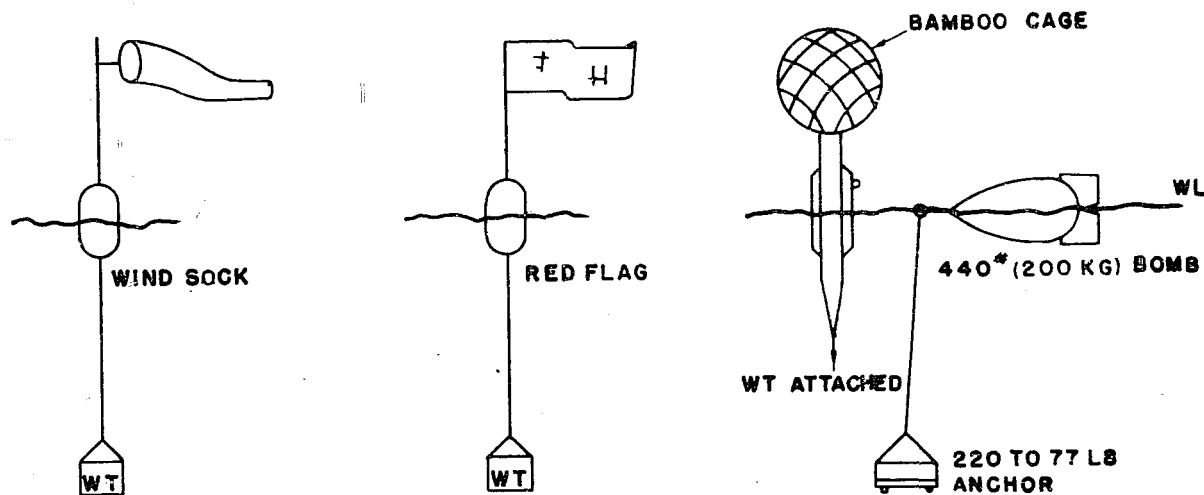

Figure 10

DEVICES FOR MARKING SHIPPING LANES AROUND MINED AREAS

The organization for the acquisition and promulgation of information concerning waters dangerous due to mines has been discussed in a previous part of this report.

#### Part XII JAPANESE DEFENSE TACTICS AGAINST AERIAL MINING

As stated before, the Japanese were not prepared for the Allied aerial mining campaign. However, the BOBITAI, or Coastal Defense Unit, was soon established to coordinate all counter-measures against mining attacks. The main units of the BOBITAI were radar stations, searchlights, mine watches, and anti-aircraft batteries. These units were placed around important harbors and waterways where mining seemed imminent. The coordination of operations was approximately as follows:

Approaching aircraft were picked up by the radar stations and tracked to within range of the searchlights. While the searchlights followed the planes, mine look-outs watched for dropped mines, which could be spotted by their white parachutes. The position of each mine was marked as accurately as possible on a map. This information was sent to the nearest naval base. The liaison officer at the naval base forwarded the information to TOKYO and also warned vessels in the immediate locality of the mined area. TOKYO broadcasted the warning to all ships concerned.

The anti-aircraft batteries were not effective and were seldom used, because the B-29's were too high to be reached. Captain KUNOKI, Commander of Mine-sweeping Operations, believed that, due to the speed of planes, they could have flown much lower without greatly endangering the aircraft. This would have given more accurate drops and thus reduced the large number of mines dropped on land.

Both Army and Navy fighter interception squadrons were used, but sufficient planes were not available to give an effective defense. During the latter part of the mining campaign no planes were available for interception squadrons.

During the last few weeks of the war an attempt was made to fix the locations of mines by triangulation with three searchlights. This method did not prove satisfactory, possibly due to lack of time for training personnel.

#### Part XIII WHY BARRAGE BALLOONS WERE NOT USED

Barrage balloons never were used against the low flying minelaying aircraft in the Southwest Pacific simply because the Japanese did not have the materials necessary for their construction.

#### Part XIV MINE DISPOSAL TECHNIQUES

There is no written record of the mine disposal techniques used by the Japanese. A pamphlet which was being prepared on the subject at the Kurihama Mine School, was claimed to have been destroyed.

When a new mine was discovered, some mine expert was called to render it safe. It then was sent to the Mine Research Laboratory at the Yokosuka Navy Yard for analysis. The time required to work out counter-measures for each type of mechanism was as follows:

- Magnetic (needle type) - 1 month
- Magnetic (induction type) - 2 months
- Acoustic (normal frequency) - 2 weeks
- Acoustic (low frequency) - Unable to construct effective countermeasures, but research was completed in three months.
- Pressure type - Unable to construct effective counter-measures. but research was completed in 3 months.

(For further information see Enclosure (B) of NavTechJap Report "Japanese Mine-sweeping Gear and Equipment," Index No. S-28. See also NavTechJap Report "Japanese Bomb Disposal Methods" Index No. O-06)

The following is a list of general precautions which were to be observed and was submitted by the Japanese. It was written from memory, therefore its accuracy is questionable.

"1. The great majority of American mines are of the same appearance, but their firing mechanisms differ. The fuses, safety devices, and delay arming clocks are the same. The various kinds of firing mechanisms found in similar cases may be identified by the following diagrams (Figure 11).

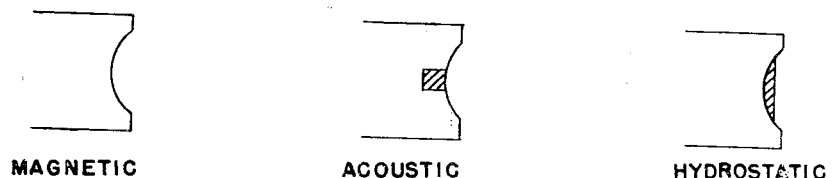

Figure 11  
DIAGRAMS OF FIRING MECHANISM IN U.S. MINES

"2. Be prepared for a booby-trap, and try to make the damage due to spontaneous explosion as slight as possible.

"3. Remove the fuse safety device by means of a rope pulled from a distance. If the soluble piece has not melted away, or lies in the case, there is no danger.

"4. Never cut two electric wires to the fuse at the same time. Cut them separately.

"5. All the removable small covers should be removed as explained in 3 and 4.

"6. Cut the electric wires from the battery one by one. The voltage is above 200 volts, so the circuits should be handled with care (handles of pliers should be wrapped).

"7. Disassembly should be carried out in such a manner that reconstruction is possible.

"8. After the removal of the firing mechanism, the mine is in a safe state, even if it contains the explosive, which is grey and looks like concrete."

Data as to time and place of recovery of U.S. mines are given in the following table.

## U.S. MINES RECOVERED BY JAPANESE

Mine Designation		Date Recovered	Place Recovered
Japanese	U.S.		
Sunken Type Magnetic Model	Mk 12 mine M-3 Mech.	May 1944	Buin, Shortland Is.
Sunken Type Induction Model	Mk 13 mine M-4 Mech.	Feb. 1944 Mar. 1944	TAKAC Harbor Burma Area
Moored Type Magnetic Model	Mk 10 mine M-5 Mech.	Apr. 1944	W. Passara Island
Sunken Type Induction Model	Mk 26 mine M9-1 Mech.	Nov. 1944	OGASAWARA Area (Chichi Jima)
Sunken Type Induction Model	Mk 25 mine M-11 Mech.	Mar. 1945	HIROSHIMA Bay
Sunken Type Acoustic	Mk 36-2 mine M-5 Mech.	Mar. 1945	HIROSHIMA Bay
American Dual Purpose Mine	Mk 25-2 mine A -5 Mech.	May 1945	KUSHIMOTO Area

Part XV  
"SELF-PROPELLED" SOUNDMAKING DEVICE

The Japanese had no "self-propelled" sound making device. The building of such a device had been considered but no experiments were conducted.

The use of torpedoes in sweeping acoustic mines was considered in a report of the Seventh Military Laboratory entitled: "Counter-measures against U.S. Acoustic Mines" (See Enclosure (B) of NavTechJap Report "Japanese Minesweeping Gear and Equipment," Index No. S-23).

## ENCLOSURE (A)

JAPANESE HANDBOOK FOR MAGNETIC AND ACOUSTIC MINES AND SWEEPS,  
PART 2 (TRANSLATION)1. GENERAL

To obtain ideal performance of special sweep gear it is necessary to sweep in a manner applicable to the characteristics of the mine to be swept. The following paragraphs explain various sweeping methods. Even at a considerable distance from the hull of a ship engaged in sweeping operations changes in magnetic field are produced by the magnetism of the hull, and sound waves are produced by the ships propeller. Perfect sweeping gear does not exist.

a. Magnetic Mine Sweeping Gear. There are two methods, namely: utilization of the magnetic field produced by a permanent magnet, and utilization of the magnetic field produced by the flow of electric current through a wire.

In the case of the magnetic mine of the needle type it is possible to proceed merely by setting up a magnetic field; but in the case of the induction type mine the effect is controlled by the speed at which the sweeping gear is towed or, if it is an induction (T. N. TSUDEN) type sweep, by inducing a current.

b. Acoustic Minesweeping Gear. There are two methods by utilizing a sound emitting missile (HATSUODAN), which uses the sound of an explosive charge; and by producing a continuous sound in the water. Since, hitherto, all mines have operated by audible sound waves, all these have been the objective.

GENERAL PRECAUTIONS IN SWEEPING

a. Distinctions. In case one cannot tell what sort of mines are being swept, consider them as magnetic and acoustic mixed.

b. Sweeping Interval. The setting of the clock delay mechanism can be up to a maximum of 45 days and although it depends on the number of mines and the field, the sweeping interval should be extended to a period of suitable length.

c. Number of Sweeps. You must sweep back and forth, employing the same method of sweep, long enough to operate the clock delay mechanism a maximum of twelve times.

d. Interval of Delay. It is necessary to sweep at the slowest possible speed. It is also necessary to set the induction (T. N. TSUDEN) interval properly (up to the present time four seconds has sufficed). As for sound emitting missiles, except for the Mark 5, they are dropped in clusters of several at short intervals so that they produce a continuous sound.

e. Effective Area of Sweep. In the case of sunken mines, sweeping to a depth up to 50 meters (164 ft.) is generally adequate. In the case of moored mines it is necessary to sweep up to a depth of 200 meters (656 ft).

f. Sweep Buoys. Essential for keeping to a minimum the extent of sweeping.

g. Sweeping Course. Since in the induction type mine the receiver coil is sensitive in only one direction, the courses should be in at least two directions, perpendicular to one another if possible.

## ENCLOSURE (A), continued

h. Appropriate Length of Sweeping Plumbet Cord Based on Depth of Water. In the case of insensitive mines the effective distance is greatly decreased; readjustment in the length of the sweeping plummet cord must be made in accordance with the depth of the water.

i. Sweeping Boats. Small wooden boats are used most effectively.

j. Maintenance. Although results can be achieved by rough handling, to avoid excessive labor be as careful as possible (losses are easy, repairs difficult).

3. SWEEPING METHODS FOR SPECIAL TYPES OF MINES See Table I(A).

4. TYPE 3 SWEEP GEAR - MAGNETIC ROD TYPE

This sweep gear is used in sweeping anti-warship type magnetic mines and employs the greater part of English sweep gear recovered in January 1942. It can detonate and dispose of the various types of magnetic mines within a radius of three meters (9.48 ft.), more or less, by means of a magnetic field produced by electric (magnetic) rods attached to the sweep cable. Model 2 (see Figure 2(A)) is constructed from parts of Model 1, and requires about 15 persons to operate. It is difficult to recover it in depths of over 30 meters (98.4 ft). It is most effectively used by a single ship, and can even be dragged lengthwise.

Weight: Model 2 when assembled - about 900 kg (1980 lbs)  
 Single magnetic rod in air 7.87 kg (17.4 lbs)  
 Single magnetic rod in water 6.85 kg (15 lbs)

Method of mounting: It is usually attached to the hull of the ship; attaching it to the deck is difficult, and makes streaming dangerous.

5. MAGNETIC CABLES

In order to improve the Type 3 Magnetic Bar and improve its sweeping capacity, a magnetic cable is attached to the magnetic bar and magnetized by a simple magnet. By this improvement, the length of the bar is increased from the present 800 millimeters (31-5/8 inches) to eight to ten meters (26.24 to 32.8 feet), thereby increasing its effective range. Thus the sweep is able to cover a larger area than before.

Construction details are:

Diameter - 24 millimeters (0.94 inch)

Length of cable magnetized - 5 to 10 meters (16.4 to 32.8 ft), as shown in Figure 2(A).

In place of the above it is possible to use several strands of thin cable (surface area should exceed that of the single cable of 24 millimeters diameter). Method of magnetizing - Take a cylindrical coil (solenoid) and, while passing a direct current through it, pass the cable through the coil at a rate of less than one meter per second. Repeat procedure three times. The poles are as shown in Figure 2(A). Magnetic cylinder - Use an internal magnetic field of more than 150 gauss.

The cylinder on which the wire is wound is made of metal, although it can be made of bamboo. Efficiency is greatest when the internal diameter of the coil just permits the cable to pass through. The length of the coil depends on the circumstances.

When using the magnetometer for test, the reading should be more than ten. This value is equivalent to a normal reading of 35 for the magnetic bar.

Table I(A)  
SWEEPING METHODS FOR SPECIAL TYPES OF MINES

TYPES OF MINES	SENSITIVITY	APPROPRIATE SWEEP GEAR*	NOTES - PULSE INTERVALS
BAJIN Sunken type magnetic model (Used with parachute)	20 mg	Type 2 Type 3 (magnetic rod type) Type 4 (submerged type) Type 5 (3-boat type)	0 1 2 3 4 5 seconds
TAKAO Sunken type induction model	1.7mg/sec Operates at ± 5mg when revolving at high speed	Type 3 (magnetic rod type) Type 5 (3-boat type) Type 4 (submerged type) Net sweep gear (T.N. Kaitai Sokaigu)	0 1 2 3 4 seconds and 0 1 2 3 4 Carried out 8 times at intervals of over 15 seconds.
PALAU Moored type magnetic (Used with parachute)	30 mg	Type 5 (3-boat type) Small type sweep gear, Grapple-severer Type 2	0 1 2 3 4 5 seconds
CHICHIJIMA Sunken type induction (Used with parachute)	1.0mg/sec Operates at ± 5mg when revolving at high speed	Type 5 (3-boat type) Type 3 (magnetic rod type) Type 4 (submerged type) Type 2	1 sec 2 min 5 min 2nd pulse emitted an instant after first 1 sec 2 min 6 min Carried out 10 times at intervals of 6 minutes
HIROSHIMA BAY Sunken type induction (Used with parachute)	11mg/sec Operates at ± 16mg when revolving at high speed	Type 5 (3-boat type) Type 3 (magnetic rod type) Type 4 (submerged type)	1 min 50 sec 3 min 11 sec 40 sec 11 sec 3 min 11 sec 1 min 50 sec 40 sec Carried out 8 times at intervals of 3 min 40 sec
HIROSHIMA BAY Sunken type Acoustic (Used with parachute)	350 to 500 cycles, 100 microbars	Underwater signal gear Mark 5 sound emitting missile (clusters of 5) Mark 3 sound emitting missile	The sound pulse must be precise and continue over an interval of more than 3 seconds.

\* See notes on page 32.



## ENCLOSURE (A), continued

Notes on Appropriate Sweep Gear  
See Table I(A)

1. Type 5 Sweep Gear .... Sweeping range extensive and effective, but requires generator and cable.
2. Type 3 Sweep Gear ..... Requires only a steel cable and is easy to operate but sweeping range is limited (ideal to use with Type 5).
3. Type 4 Sweep Gear ..... The first thing to do when electric cable is available in ample quantities, is to lay in important channels.
4. Small Type Sweep Gear ..... Not necessary in shallow water, less than 30 meters, when dealing with moored mines.
5. Submarine Sweep Gear
6. Type 2 Sweep Gear ..... Requires special cable and large generator over 40 kw; unsuitable in streams and rivers.

Table II(A)  
EFFECTIVE RADIUS OF TYPE 3 SWEEP GEAR

Type Mine	Japanese Designation	Sweeping Speed (knots)	Effective Radius		Remarks
			meters	feet	
Magnetic needle type	German type	6	2.6	8.5	Slightly larger than Buin type
	Buin	4	4.0	13.1	
	Palau	2	4.3	14.0	Delay up to 3 sec
Induction type	Takao	2	4.0	13.1	Increases at higher speeds
	Chichi Jima	2	5.0	16.4	Ineffective at speeds greater than 2 kts
	Hiroshima Wan	2	2.0	6.5	Two revolutions necessary

ENCLOSURE (A), continued

FORMATIONS

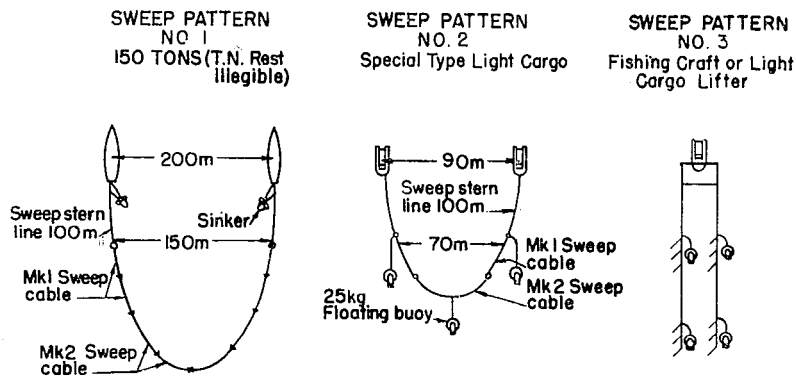

ESSENTIAL DATA

MAGNETIC ROD  
HITOKU F.W. Manganese chrome steel

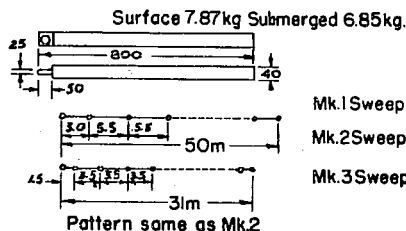

There are nine places for magnetic rod attachment on each type of cable

BUOY

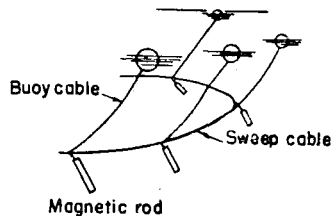

VARIATIONS OF SWEEPING SPEEDS  
WITHIN OPERATIONAL LIMITS (Experimental Results)

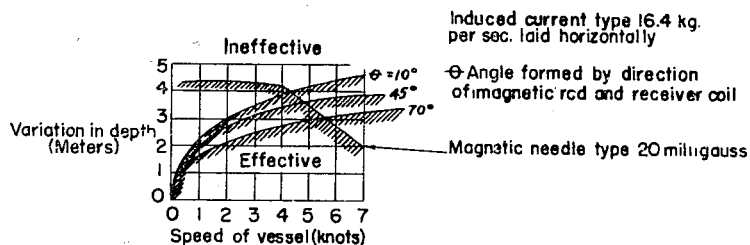
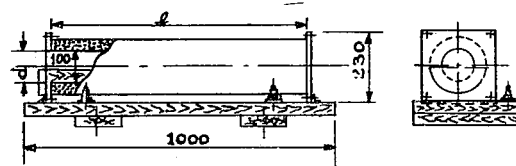

Figure 1(A)

MAGNETIC SWEEP FORMATIONS AND CABLE DATA

## ENCLOSURE (A), continued



Dia. of line 2.6mm (0.1in.)  
 Electric pressure 100 volt.  
 Magnetic field 14 "  
 Magnetic field 1200 gauss  
 170 "  
 Load capacity 1600 kg.  
 Electric flow 51.8 amps.  
 7.25 "

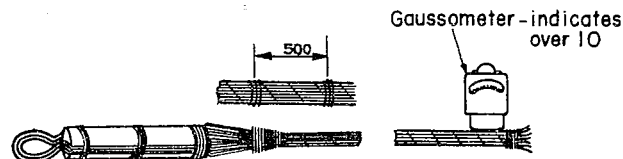
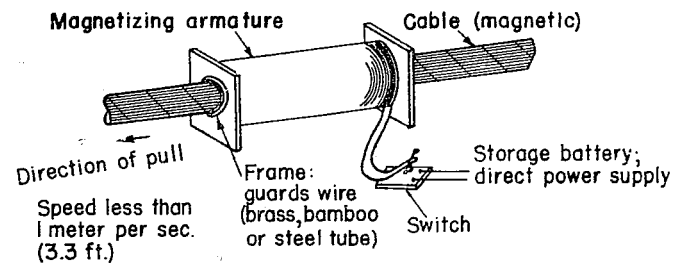

The strength of the inner part of the magnetic field  $H$

is found as follows:

$$H = 12.57 \times nI$$

$n$  = number of turns in coil, must be multiplied by 10

$I$  = current capacity (unit amperes)

Unit of  $H$  is gauss

When  $l$  is shorter than  $d$ , corrections must be made -

When  $l = 2d$  the ratio is 0.8944 and  $H = 11.25 nI$

$l = 4d$  " " 0.9701 "  $H = 12.20 nI$

$l = 6d$  " " 0.9864 "  $H = 12.40 nI$

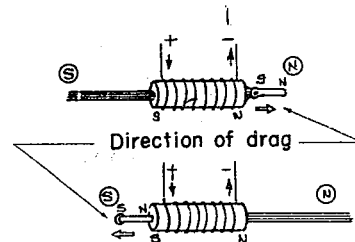

North and south poles of the magnetizing armature vary according to the direction of electric flow in the coil. Seen from the end, the north and south poles of coil are shown (the arrow indicates direction of electric flow)

Figure 2(A)

MAGNETIC ROD SWEEPER USED IN MODEL 2 TYPE 3 SWEEP GEAR

RESTRICTED

O-03

ENCLOSURE (A), continued

Since the cable was tested for 14 days and struck a great many times by large waves, with negligible loss of magnetism, the life of the cable can be guaranteed for ten days.

(Note - A modified type can be used which makes use of the cable without the bar).

6. TYPE 4 SWEEPING DEVICE MOORED TYPE. (Figure 3(A))

This sweeping device is one which can dispose of magnetic mines at any time over a large area within channels (includes swept channels), anchorages, etc., by means of local wire and electric power.

The area of disposal depends on the type of wire (completely waterproof), its length, and the power generated (direct current). It is installed, after one or more coils are moored to the sea bottom.

ENCLOSURE (A), continued

LAYING SKETCH

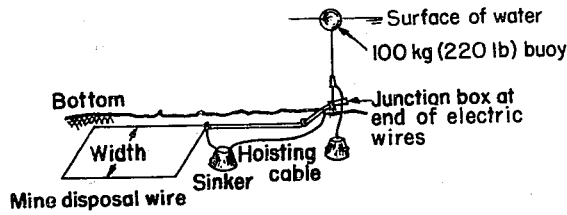

Magnetic mine sensitivity. Amount of flow of current. Relations of intervals between wires.

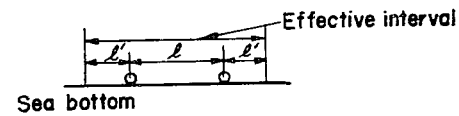

SKETCH OF TERMINAL

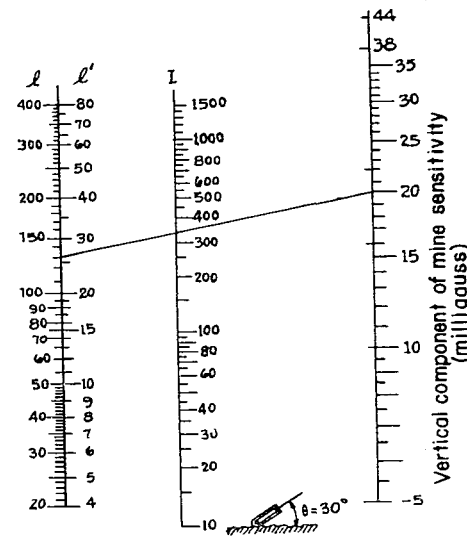
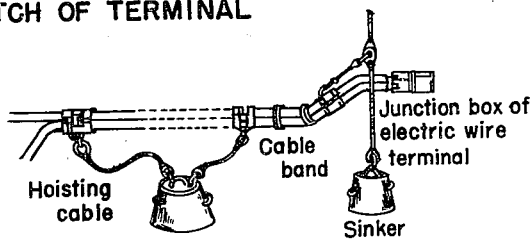

DISPOSITION SKETCH

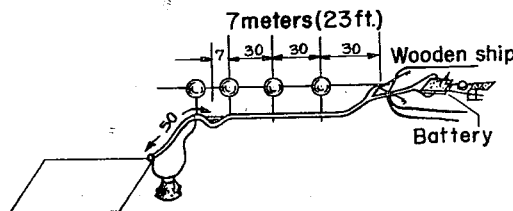

TYPE (N. PARTIALLY ILLEGIBLE)	SENSITIVITY	MINE SENSITIVITY TAKEN ON LINE TO RIGHT	
		AT 90°	30° OR OVER
TAKAO	1.7 MG	5 MG	10 MG
CHICHI JIMA	1.0	3	6
HIROSHIMA BAY	11	16	32
ENGLAND	20	22	44

Figure 3(A)  
TYPE 4 SWEEPING DEVICE

ENCLOSURE (A), continued

CHARACTERISTICS OF SQUARE TYPE SWEEPING CABLE

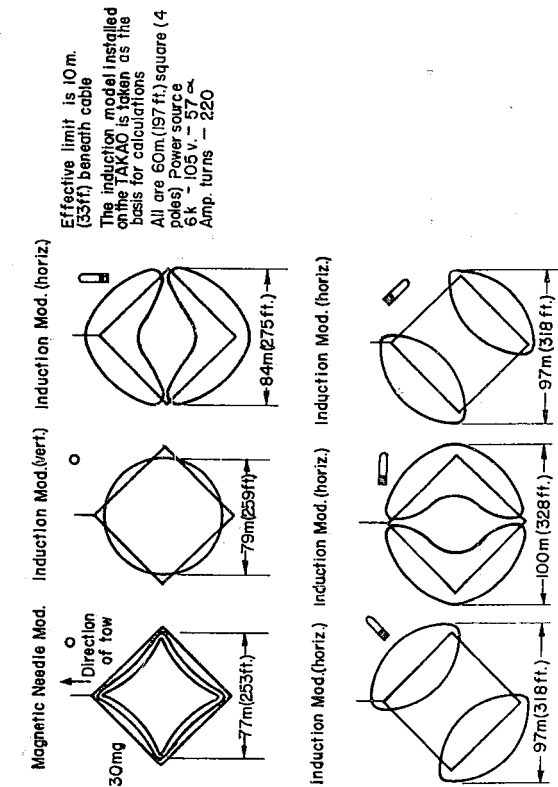

INSTALLATION DIAGRAM

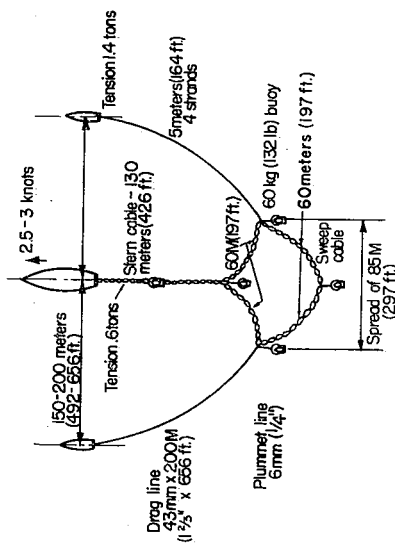

WIRING DIAGRAM

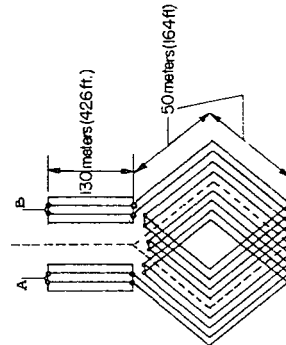

LIST OF DETAILS

- Finished outer dia. 28mm (1 in. \*)
- Reinforced center 36/1.8 mm
- \* Weight in air 480kg (1056 lbs)
- Weight in water 260kg (572 lbs)
- Induction resistance 338 \*
- Distance A-B 1.34 \*
- \* T.N. Illegible

PARTICULARS CONCERNING CARRYING AND STREAMING OF SWEEP CABLE

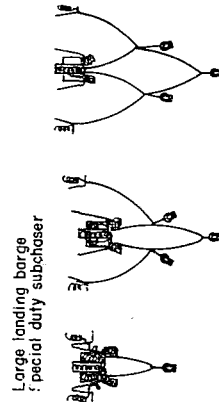

Figure 4(A)  
TYPE 5 SWEEPING DEVICE

*ENCLOSURE (A), continued*

The effective breadth of sweep varies depending on the type of mine (in the case of the ground induction types, the angle formed by the direction of the drag is included) and, according to computations, the results indicated in the diagram will be obtained if the field is kept square.

When the performance of the generator is good and the current produced is high (220 ampere turns), the 60 meters (196.8 feet) cables can be increased in length and the effective width increased.

It is advantageous to set the breadth of the sweep as wide as possible and then narrow the space between the front and rear of the sweep. However, when this space has been reduced as far as possible, care should be taken to decrease the interval between pulses.

#### 8. NOISE EMITTING MISSILES (Figure 5(A))

To obtain an acoustic mine detonating device which uses gun powder, a study has been made of the results of underwater explosions of every type of noise emitting missile hitherto used. In addition, experiments are under way on a special sound shell (Mark 5) containing five shells which go off in succession (time interval 0.5 second).

Mines which have the characteristics of the temporarily designated Type 3 Model 2 mines, can be disposed of if they lie within the limits of the hatched area in the zone of effectiveness sketch in Figure 5(A). Near the point where it is dropped the sound of the explosion is too great and it cannot cause detonation; and outside the circle, the mines, in general, are not sensitive to the sound.

Against the special acoustic mines now under experimentation and which are sensitive to supersonic waves, the Mark 3 noise missiles detonate only those which lie within a radius of about 65 meters (213.1 feet) distance.

Satisfactory results were obtained in using Mark 3 noise missiles as a sweep against mines laid in HIROSHIMA Bay.

The ratio of the time between the dropping of the missile and the detonation of the mine to the distance between the vessel and the mine gives the sweeping speed. With a distance of 200 meters (656 feet), the most appropriate speed is found to be three knots. At this speed the vessel is assured a certain degree of safety. As a counter-measure against duds it is necessary to drop two shells at a time. (Mark 3 sound shells every 150 meters and Mark 5 shells every 400 meters.)

When the seal over the inlet hole of the missile is opened and the missiles are dropped into the water, the sodium and water combine and explode. Because of this, the friction fuze is set off, the flame hits the safety fuze, and after a short delay, the charge is ignited.

#### 9. ACOUSTIC MINE SWEEPING GEAR UNDER INVESTIGATION

In the field of acoustic minesweeping gear, in addition to the aforementioned noise missiles, there is the Fessenden underwater signal device. There are also the two types enumerated below. Although experiments on the first device have been completed, neither device has yet been made practical:

- a. Steam blowing method.
- b. Drum beating method.

ENCLOSURE (A), continued

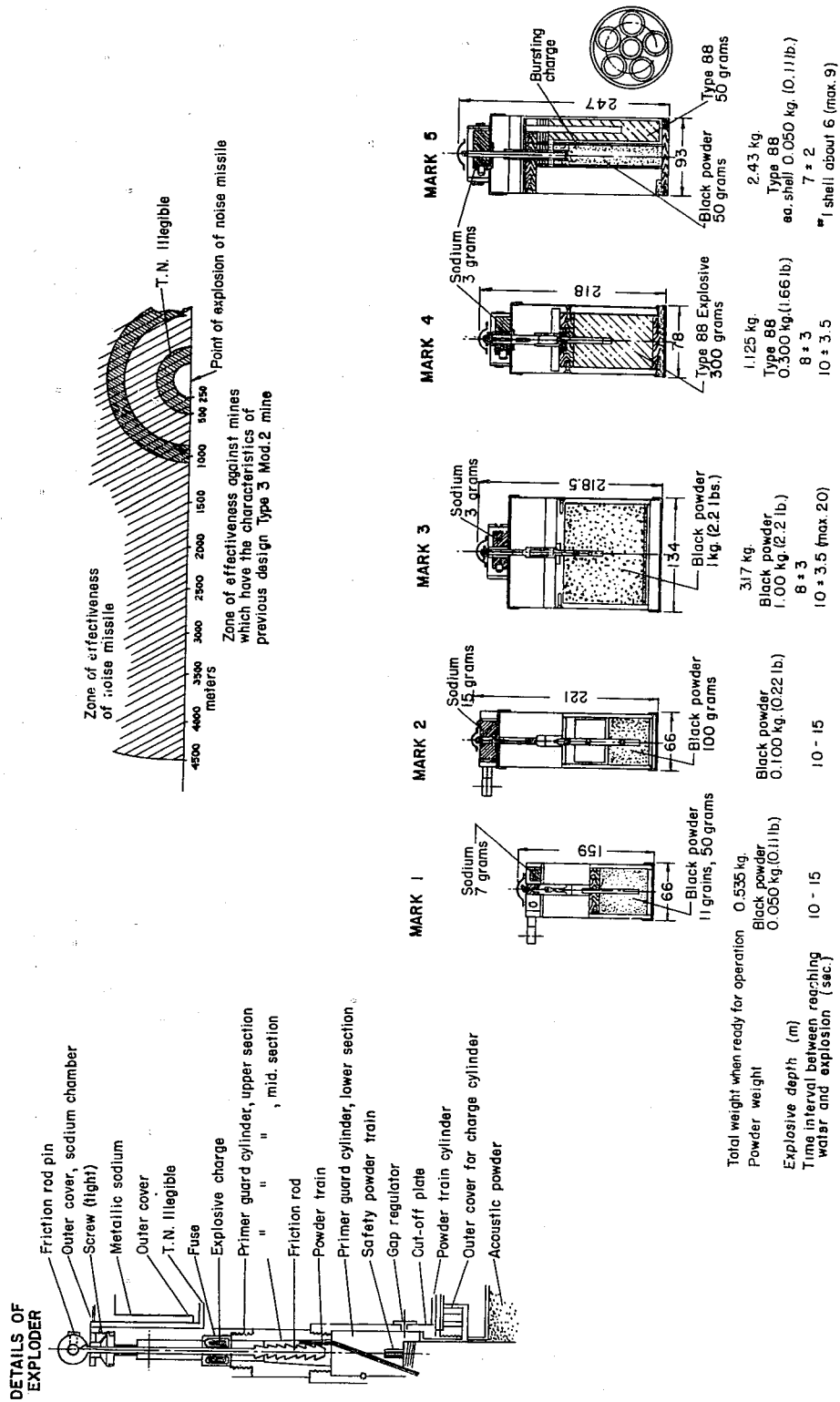

Figure 5(A)  
TYPES OF NOISE EMITTING MISSILES



ENCLOSURE (A), continued

STEAM BLOWING METHOD

No. 1

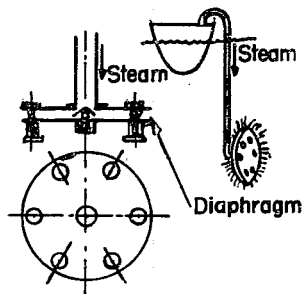

No. 2

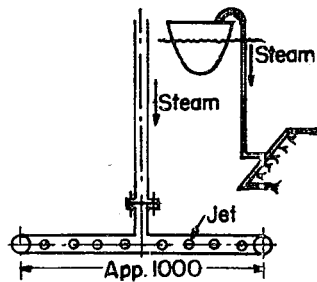

No. 3

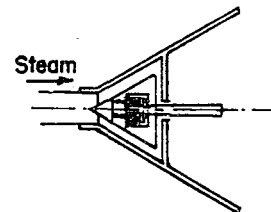

REQUIRED CAPACITY:  
 12 HP 8 kg/cm<sup>2</sup> (114 lb/in<sup>2</sup>)  
 Boiler - 17 HP 10-11 kg/cm<sup>2</sup> (142-156 lb/in<sup>2</sup>)

DRUM BEATING METHOD

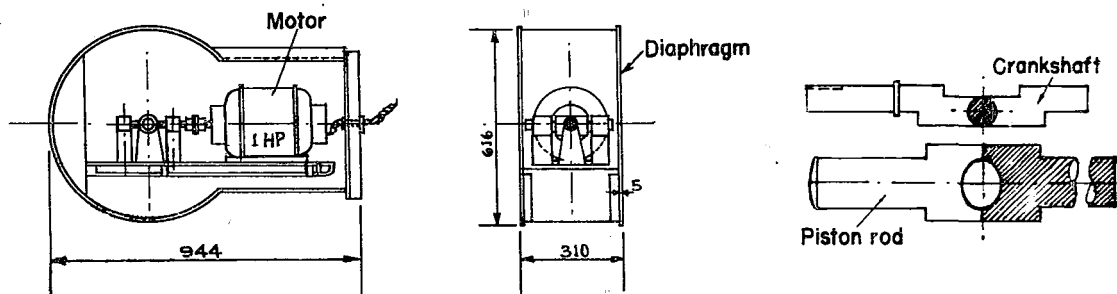

Figure 6(A)  
 ACOUSTIC MINE SWEEPING DEVICES

## ENCLOSURE (B)

PRINCIPAL ITEMS OF JAPANESE NAVAL SWEEPS  
(TRANSLATION)SMALL SWEEP, MODEL 1 MODIFICATION 1.

**Object:** This sweep is towed between two boats or launches. It catches a mine, and is used instead of Middle Sweep.

**History:** This was experimentally constructed and tested at the Mine Experiment Department in accordance with the Fleet Headquarter's Top Secret Order No. 3571, issued 26 September 1931.

## MAIN ITEMS OF OUTFIT

Items (See Figure 1(B))	No/Set	Details
A Sweep wire (I)	4	Diam. -5mm Length -50m
B Sweep wire (II)	4	Diam. -5mm Length -50m
C Tail Wire	2	Diam. -6mm Length -5m
D Buoy	5	Buoyancy -11 kg, fitted with lifting plane
E Buoy wire (short)	10	Diam. -3mm, Length -5m
F Buoy wire (long)	5	Diam. -3mm Length -10m
G Shackle	5	
H Shackle	5	
I Swivel & Shackle	20	
J Swivel & Shackle	4	
K Swivel & Shackle	5	
L Shackle	10	

## Operational Data:

Length of sweep wire ..... 400 m  
 Distance between ships ..... 200 m  
 Depth of sweep ..... 7-15 m  
 Speed ..... 5 kts  
 Spread of sweep ..... 150 m

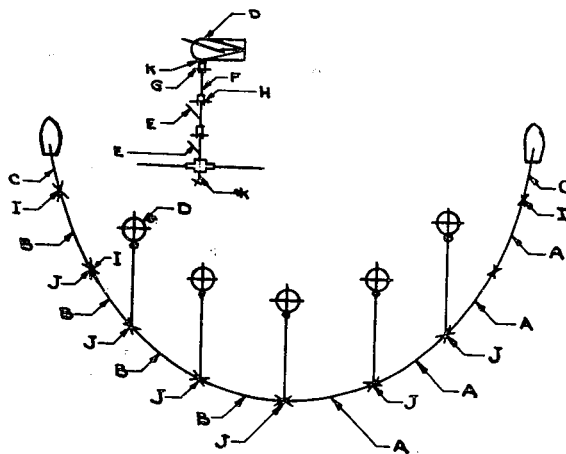

Figure 1(B)  
SMALL SWEEP, MODEL 1 MODIFICATION 1

#### SINGLE SHIP LARGE SWEEPING GEAR

Single ship sweeping gear towed by a destroyer or a minesweeper is used to catch moored mines and take the mooring cable in tow by the sweep wire or sever it by a cutter. It is used for search sweeps, rough sweeps (TN sic), and daylight screening sweeps.

This gear was tested on 7 March 1919 by the Yokosuka Navy Yard Ordnance Department as a result of Navy Ministry Most Secret Directive No. 264. It was adopted for service in October 1921.

#### MAIN ITEMS OF OUTFIT

Designation	Items See Figure 2(B)	Number of Personnel to Handle Each	Specifications
Single Ship Sweeping Gear (Formerly des- ignated "High Speed Sweeping Gear")	A Sweep Wire	2	Circumference-54mm; special steel cable; port-1 line, starboard- 1 line; length-275m; weight-375.125 kg.
	B Sinker tow cable	1	Circumference-57mm; Mk 4 steel cable; length 125m; weight- 171.875 kg.

## ENCLOSURE (B), continued

## MAIN ITEMS OF OUTFIT (Cont.)

Designation		Items See Figure 2(B)	Number of Personnel to Handle Each	Specifications
Single Ship Sweeping Gear  (Cont.)	C	Sinker weight cable	1	Circumference-57mm; Mk 4 steel cable; length-4m; weight-5.500 kg.
	D	Paravane	2	Refer to outline for Mk 2 paravaning gear
	E	Sinker	1	Weight-125 kg; buoyancy- 31 kg.
	F	Coupler	2	For paravanes; weight- 12.260 kg.
	G	Coupler	1	For sinker; weight- 11.600 kg.
	H	Four way junction plate	1	Weight - 1.870 kg.
	I	Pulley	2	Weight-20.868 kg.
	J	Pulley cable	2	Circumference-57mm; 2-ply Mk 4 steel cable; lead by Manila rope of 2mm diameter; length- 540mm
	K	Sinker tow cable brake	1	
	L	Hoisting gear	2	
	M	Paravane streaming gear	2	
N	Davit	1		

## Operational Data:

Width of Sweep 110m (The 110m sweeping width, after the sweep wire has been paid out 180m and the sinker tow cable 48m, will not increase above 120m sweeping width even with extension of the sweepwire.)

Sweeping Depth 6-18m

Sweeping Speed 6-26 kts. (Maximum rated speed is 28 kts. However, the speed range suited to the life span of the sweepwire is from 15 to 20 kts.)

ENCLOSURE (B), continued

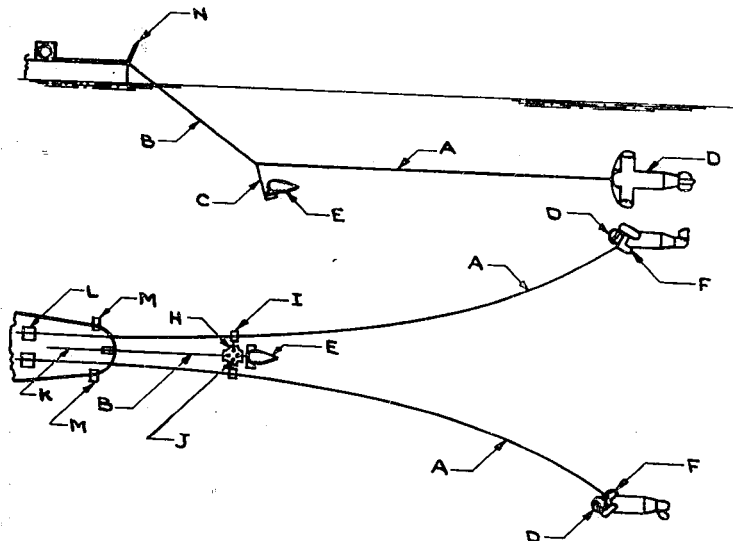

Figure 2(B)  
SINGLE SHIP SWEEPING GEAR

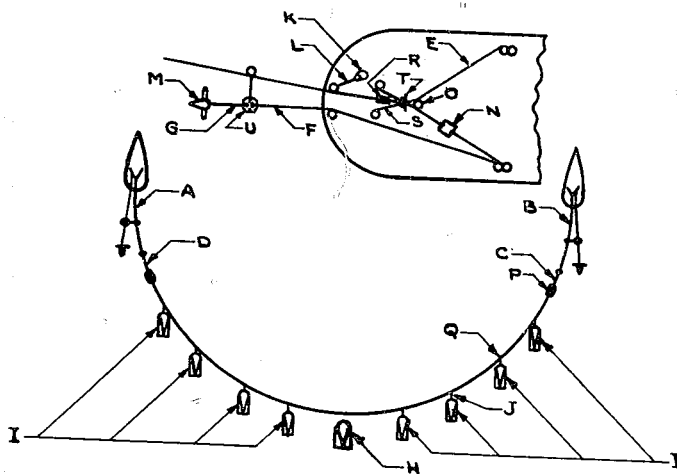

Figure 3(b)  
TWIN SHIP LARGE SWEEPING GEAR, MODEL 1

## ENCLOSURE (B), continued

Sweeping Speeds Kts	12	15	18.5	20	25
Actual Speeds Kts	10.2	12.9	16.1	17.4	22.6
Tension (Metric Tons)	1.7	2.2	3.0	5.5	6.0
Speeds for Streaming and Recovering Gear	Suitable range is between 6 and 12 kts.				
Cutting Capacity	Practically certain to sever a mooring cable of 44mm or less in circumference.				
Depth Error	There will be a maximum difference of 1m between regulated depth and actual depth.				
Paravane Stability	Paravanes will operate most smoothly at a speed of about 25 kts.				

TWIN SHIP LARGE SWEEPING GEAR, MODEL 1

**Object:** This sweep is towed at high speed between two destroyers or sweepers. When the sweep catches a mine, the mine is dragged to deep or shallow water and rendered ineffective.

**History:** It was experimentally constructed and tested at the Mine Experiment Department, in accordance with the Secretariat Top Secret Order No. 258, issued 26 March 1931.

**Date Adopted:** January 1934

**Former Name:** High Speed Sweep, in pairs

## MAIN ITEMS OF OUTFIT

Items See Figure 3(B)	No/Set	Items
A Tail wire I	1	diam-18mm, "S" strand, length-100 m
B Tail wire II	1	diam-18mm, "Z" strand, length-100 m
C Sweep wire I	6	diam-16mm, "S" strand, length-100 m
D Sweep wire II	6	diam-16mm, "Z" strand, length-100 m
E Tow wire	2	diam-18mm, length-40 m
F Depressor wire	2	diam-18mm, "S" and "Z" strand, length-125 m
G Depressor pendant	2	diam-18mm, length-4 m
H Buoy	1	buoyancy-120 kg

## ENCLOSURE (B), continued

## MAIN ITEMS OF OUTFIT (Cont.)

Items See Figure 3(B)	No/Set	Items
I Buoy	8	buoyancy-100 kg, no lifting plane
J Buoy wire	9	diam-12mm, length-1 m
K Buoy	2	buoyancy-23 kg
L Bouy rope	2	diam-12mm, Manila rope, length-150mm, used for 23 kg buoy
M Depressor	2	
N Tension-meter	2	18 tons
O Pulley	4	
P Snatch block I	4	
Q Snatch block II	9	
R Snatch block III	2	
S Rope		diam-9mm, hempen rope, length-3 m
T Slip and chain	2	
U 4-eye block		

## Operational Data:

Length of sweepwire ..... 1,400 m  
 Distance between ships ..... 600 m  
 Depth of sweep ..... 11 m  
 Speed ..... 16 kts  
 Actual speed ..... 13 kts  
 Spread of sweep  
     when depressor is used ..... 550 m  
     when depressor is not used ..... 350 m  
 Streaming speed ..... 6 kts  
 Tension ..... 3.5 to 6.8 tons

TWIN SHIP LARGE SWEEPING GEAR, MODEL 2

**Object:** This sweep is towed between two destroyers or sweepers. When the sweep catches a mine, the mine is dragged to deep or shallow water and rendered ineffective. It is used to sweep roads or straits.

**History:** It was first manufactured in October 1921.

**Date Adopted:** February 1934

**Former Name:** Large Sweep Mark 2 (special)

## ENCLOSURE (B), continued

## MAIN ITEMS OF OUTFIT

Items See Figure 4(B)		No/Set	Details
A	Sweep wire	24	diam-16mm, steel rope, Mark 4, "S" strand-12, length-50m; "Z" strand-12, length-50m
B	Buoy wire	19	diam-9mm, steel wire rope, Mark 4, length-500 mm
C	Buoy (L)	3	buoyancy-100 kg
D	Buoy (S)	16	buoyancy
E	Swivel and shackle	19	includes snatch
F	Swivel and shackle	6	
G	Buoy	2	buoyancy-23 kg, painted red
H	Buoy rope	2	diam-12mm, Manila rope
I	Setting eye	2	length-150m, for 23 kg buoy.
J	Ship and chain	2	
K	Tension-meter	2	oil pressure system
L	Shackle (S)	42	
M	Shackle (L)	4	
N	Ring	2	

## Operational Data:

Length of sweepwire .....	1,200 m
Distance between ships .....	600 m
Speed .....	12 kts
Actual speed .....	9.6 kts
Effective spread of sweep .....	480 m
Depth of sweep .....	8-30 m
Suitable speed for streaming .....	6 kts

TWIN SHIP LARGE SWEEPING GEAR, MODEL 3

**Object:** This single sweep is towed between two sweepers. When the sweep catches a mine, the mine is dragged to deep or shallow water and rendered ineffective. Used for daylight sweeping.

**History:** This was experimentally constructed and tested at the Mine Experiment Department in 1928.

**Date Adopted:** January 1934

**Former name:** Large Sweep Mark 2 A (KO)



## ENCLOSURE (B), continued

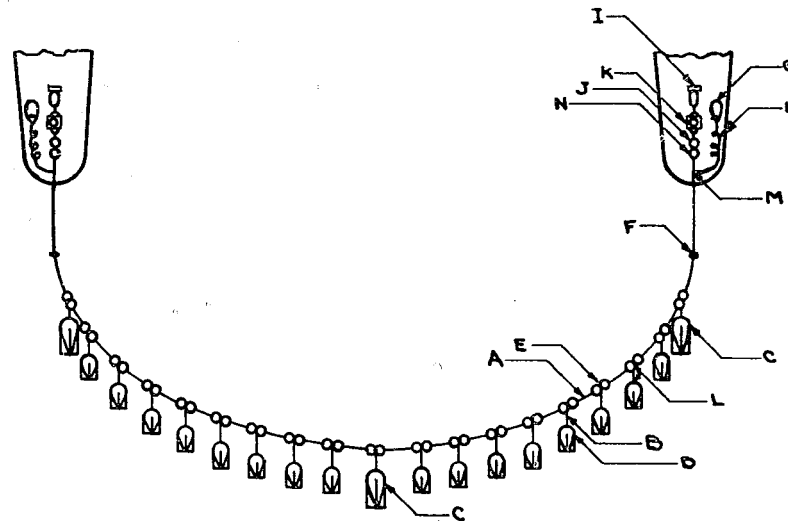

Figure 4(B)  
TWIN SHIP LARGE SWEEPING GEAR, MODEL 2

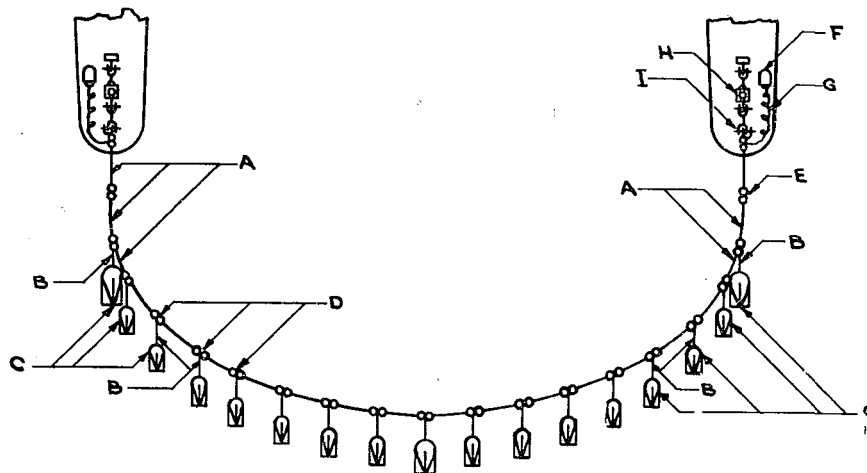

Figure 5(B)  
TWIN SHIP LARGE SWEEPING GEAR, MODEL 3

## MAIN ITEMS OF OUTFIT

Items See Figure 5(B)		No/Set	Details
A	Sweep wire	20	diam-10mm, steel wire Mark 3; "S" Strand-10, length-100m; "Z" Strand-10, length-100m
B	Buoy wire	17	diam-9mm, steel wire Mark 4, length-500mm
C	Buoy	17	buoyancy-60kg, no lifting plane, painted white-14, painted red-3
D	Swivel and shackle	17	includes connector
E	Swivel and shackle	4	
F	Buoy		buoyancy-23kg, painted red
G	Buoy rope	2	diam-12mm, length-150m, Manila rope
H	Tension-meter	2	oil pressure system
I	Towing set	2	

## Operational Data:

Length of sweepwire ..... 2000 m  
 Distance between ships ..... 1000 m  
 Depth of sweep ..... 26 m  
 Speed ..... 12 kts  
 Actual speed ..... 10 kts  
 Effective spread of sweep ..... 800 m  
 Tension ..... 2.8 ton

TWIN SHIP LARGE SWEEPING GEAR, MODEL 4

Object: This sweep is towed between two sweepers. The mine is dragged to deep or shallow water and rendered ineffective. It is used to sweep roads or straits.

History: It was first adopted in October 1921.

Date Adopted: February 1934.

Former name: Large Sweep Mark 2 C (HEI)

## MAIN ITEMS OF OUTFIT

Items See Figure 6(B)		No/Set	Details
A	Sweep wire	16	diam-14mm, steel wire Mark 4, "S" strand-8, "Z" strand -8, length-50 m
B	Buoy wire	11	diam-9mm, steel wire Mark 4, length-500mm

## ENCLOSURE (B), continued

## MAIN ITEMS OF OUTFIT (Cont.)

Items See Figure 6(B)		No/Set	Details
C	Buoy (L)	3	buoyancy-100kg, painted red, no lifting plane
D	Buoy (R)	8	buoyancy-60kg, painted white, no lifting plane
E	Swivel and shackle	11	includes joint
F	Swivel and shackle	6	
G	Buoy	2	buoyancy-23kg, painted red
H	Buoy rope	2	diam-12mm, Manila rope, length-150m
I	Setting eye	2	
J	Slip and chain	2	
K	Tension meter	2	oil pressure system
L	Shackle (S)	26	
M	Shackle (L)	4	
N	Ring	2	

## Operational Data:

Length of sweepwire ..... 800 m  
 Distance between ships ..... 400 m  
 Depth of sweep ..... 8-20 m  
 Speed ..... 12 kts  
 Actual speed ..... 9.7 kts  
 Effective spread of sweep ..... 320 m  
 Streaming speed ..... 6 kts  
 Tension ..... 1.2 tons

TWIN SHIP LARGE SWEEPING GEAR, MODEL 5

**Object:** This sweep is towed between two destroyers or sweepers. It drags a mine and cuts the mooring wire. It is used for daylight sweeping of roads or straits.

**History:** It was experimentally constructed and tested at the Mine Experiment Department in accordance with Secretariat Top Secret Order No. 1187, issued 17 August 1923.

**Date Adopted:** June 1925

ENCLOSURE (B), continued

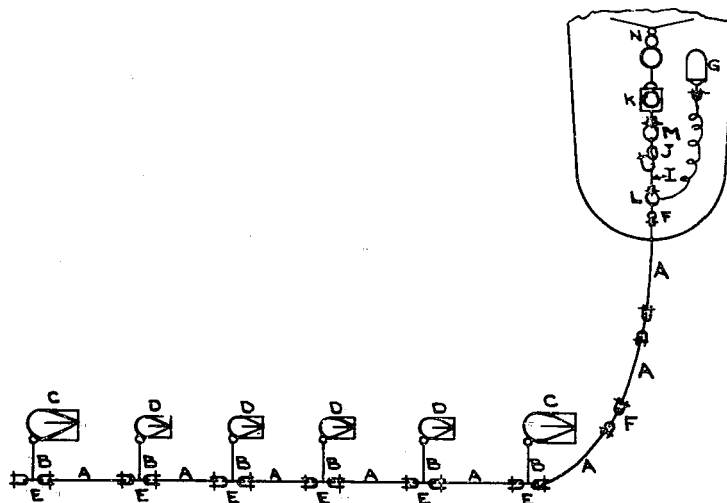

Figure 6(B)  
TWIN SHIP LARGE SWEEPING GEAR, MODEL 4

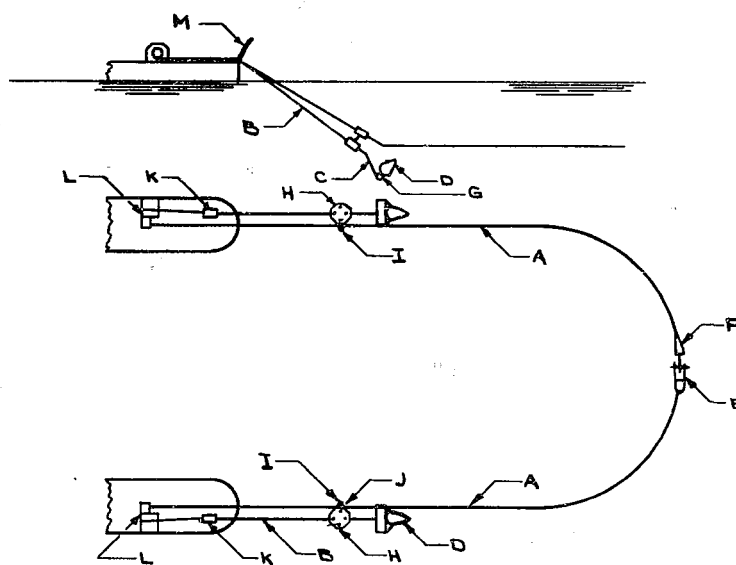

Figure 7(B)  
TWIN SHIP LARGE SWEEPING GEAR, MODEL 5

## ENCLOSURE (B), continued

## MAIN ITEMS OF OUTFIT

	Items See Figure 7(B)	No/Set	Details
A	Sweep wire	2	54mm steel wire rope special, "S" and "Z" strand, length-800 m
B	Depressor wire	2	57mm steel wire rope Mark 4, length-125 m, weight-171.875 kg
C	Depressor	2	57mm steel wire rope Mark 4, length-4 m, weight-5.500 kg
D	Depressor	2	weight-125 kg, buoyancy-31 kg
E	Sweep wire connector	2	
F	Sweep wire connecting piece	1	
G	Depressor connector	2	weight-11.600 kg
H	4 eyes plate	2	weight-1.870 kg
I	Pulley	2	weight-20.868 kg
J	Pulley setting wire	2	57mm steel wire rope Mark 4, double stranded and yarn wound (dia 2mm) over it, length-620mm
K	Depressor wire stopper	2	
L	Winch	2	
M	Depressor davit	2	

## Operational Data:

Length of sweepwire ..... 1600 m  
 Distance between ships ..... 880 m  
 Depth of sweep ..... 35 m - 20 m  
 Speed ..... 12 - 16 kts  
 Spread of sweep ..... 700 m  
 Tension ..... 1.3 - 7.3 tons  
 Cutting ability ..... under 44mm steel wire rope  
 Effective speed of sweep in Mark 1 Type sweeper ..... 12 kts  
 Suitable speed to stream sweep ..... about 6 - 9 kts

TWIN SHIP LARGE SWEEPING GEAR FOR SHALLOW WATER

**Object:** This sweep is towed between two destroyers or sweepers. When the sweep catches a mine, the mine is dragged to deep water and rendered ineffective.

**History:** It was first manufactured in December 1921.

## ENCLOSURE (B), continued

Date Adopted: January 1925

Former name: Large Sweep Mark 2 Model Modification I

## MAIN ITEMS OF OUTFIT

Items See Figure 8(B)	No/Set	Details
A Sweep wire	24	16mm steel wire Mark 4, length-50m, "S" strand-12, "Z" strand-12
B Buoy wire		9mm steel wire Mark 4, length
C Buoy (L)		buoyancy-100 kg painted red, no lifting wings
D Buoy (S)		buoyancy-60 kg, painted white, no lifting wings
E Connector	19	includes connecting piece
F Connector	6	
G Buoy	2	buoyancy-23 kg, painted red
H Buoy rope	2	12mm Manila rope, length-150 m, used for 23 kg buoy
I Setting eye		
J Slip and chain	2	
K Tension meter	2	oil pressure system
L Shackle (S)	42	
M Shackle (L)	4	
N Ring		

## Operational Data:

Length of sweepwire ..... 1,200 m  
 Distance between ships ..... 600 m  
 Speed ..... 10 kts  
 Actual speed ..... 8 - 10 kts  
 Tension ..... 5 tons

SWEEP, TYPE 2 MODEL 1

Object: This sweep is towed between two ships. Magnetic mines are exploded by the energized cable of this sweep.

Former name: None

ENCLOSURE (B), continued

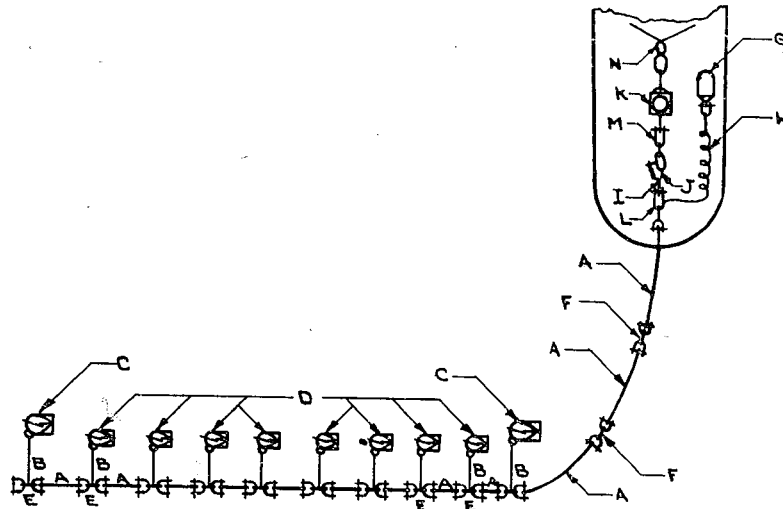

Figure 8(B)

TWIN SHIP LARGE SWEEPING GEAR FOR SHALLOW WATER

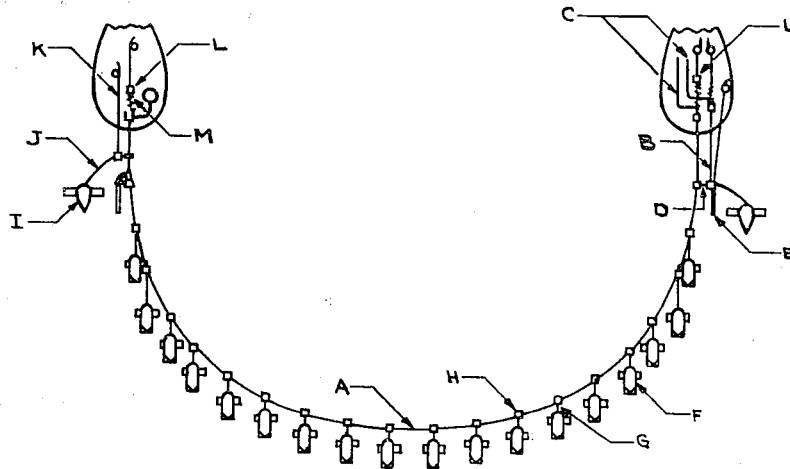

Figure 9(E)

SWEEP, TYPE 2, MODEL 1

## ENCLOSURE (B), continued

## MAIN ITEMS OF OUTFIT

Items See Figure 9(B)	No/Set	Details
A Sweep cable	1	37mm Captire cable, length-715 m
B Demagnetizing cable	1	36mm Captire cable, length-80 m
C Long lead cable	2	27.2mm Captire cable, length 25 m
D Cable-end box	4	
E Electrode	2	
F Buoy	18	bucyancy-60 kg
G Buoy wire	18	diam-8mm, length-4 m
H Cable protector	18	
I Depressor	2	buoyancy-31 kg, weight-125 kg
J Depressor wire	2	diam-8mm, length-125 m
K Depressor pendant	2	diam-18mm, length-4 m
L Tension meter	2	8 ton
M Chain	3	

SWEEP, TYPE 3 MODEL 2

Object: This magnetic sweep is towed between two small fishing vessels. Magnetic mines are exploded by the magnet bar of this sweep.

## MAIN ITEMS OF OUTFIT

Items See Figure 10(B)	No/Set	Details
A Magnet bar	36	diam-40mm, length-800mm
B Magnet for pendant	36	diam-8mm, length-2 m
C Sweepwire	4	diam-10mm length-31 m
D Buoy	3	buoyancy-25 kg
E Buoy wire	9	diam-8mm, length-20 m
F Swivel and shackle	3	
G Tail wire	2	diam-10mm, length-100 m
H Shackle	12	SIP 9



ENCLOSURE (B), continued

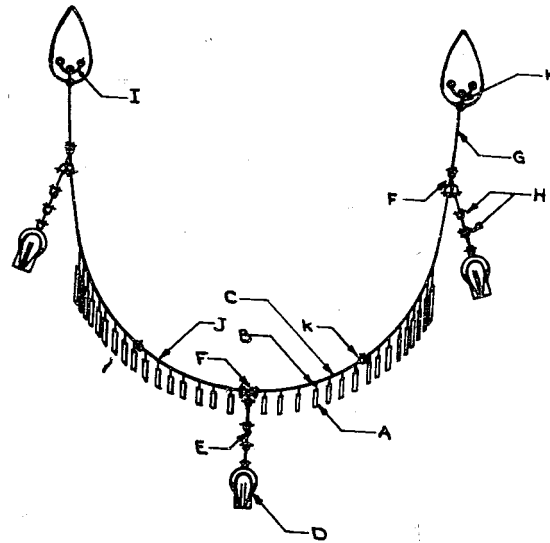

Figure 10(B)  
SWEEP, TYPE 3, MODEL 2

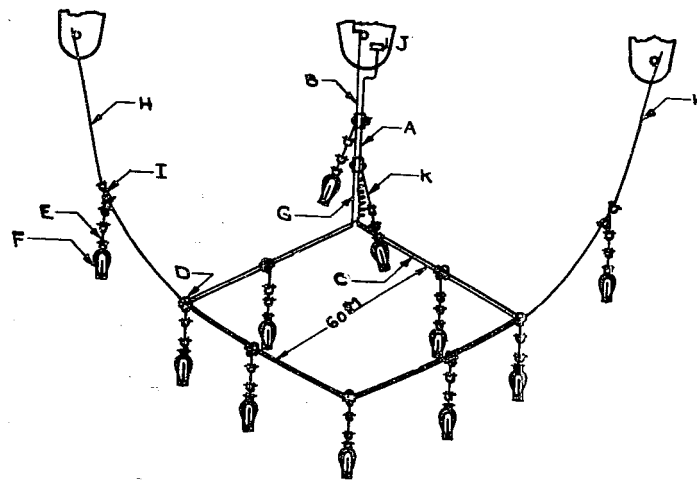

Figure 11(B)  
SWEEP, TYPE 5

## ENCLOSURE (B), continued

## MAIN ITEMS OF OUTFIT (Cont.)

Items See Figure 10(B)		No/Set	Details
I	Towing wire	2	diam-10mm, length-10 m
J	Clip	72	
K	Shackle	4	SIRI 2

## Operational Data:

Distance between ships ..... 90 m  
 Depth of sweep ..... Sea bottom  
 Speed ..... 2 - 3 kts  
 Spread of sweep ..... 50 m

SWEEP, TYPE 5

Object: This sweep is towed between two small ships. Magnetic mines are exploded by the energized cable of this sweep.

Former name: Light Magnetic Sweep

## MAIN ITEMS OF OUTFIT

Items See Figure 11(B)		No/Set	Details
A	Sweep cable	1	37mm Captire cable, length-370 m
B	Reinforcing wire (S)	1	diam-10mm, length-130
C	Reinforcing wire (L)	1	diam-10mm, length-240 m
D	Grip	9	
E	Depth wire	55	diam-6mm, length-10 m and 5 m
F	Buoy	11	buoyancy-60 kg, fitted with lifting wings
G	Ring	3	
H	Towing wire	4	diam-10mm, length-100 m
I	Swivel and shackle	2	
J	Switch		
K	Shackle	3	SIP 10

## Operational Data:

Distance between ships ..... 100 m  
 Depth of sweep ..... 5m above the bottom  
 Speed ..... 2-3 kts

## ENCLOSURE (B), continued

Spread of sweep ..... about 80 m  
 Necessary power ..... 13 kw  
 Ampere turns ..... 370 A.T.

MARK 4 SOUND PROJECTILE

Object: The projectile is used chiefly to dispose of acoustic mines by motivating their firing components through an underwater explosion.

Description: See Figure 12(B)

Overall length of projectile ..... 218mm  
 Outside diameter ..... 78mm  
 Gross weight ..... 1.145 kg  
 Submerged weight ..... 0.20 kg  
 Weight of explosive charge (Type 88) ..... 0.30 kg  
 Weight of metallic sodium ..... 1 gm (approx.)

## Operation:

The device sinks immediately when it is streamed and the wind plate has been set. Water floods into the sodium chamber through the outer flood opening. The combination of the sodium and sea water sets up a reaction giving off heat. Hydrogen is quickly generated. With the increase of pressure in the sodium chamber the cover is released. The friction element is withdrawn when the lid is released. This causes the primer to ignite. Then the booster safety fuse is ignited. Lastly, the Type 88 explosive ignites and explodes 5 sec. or so after the projectile has hit the water.

## Performance Data:

Its effective range is 1200-2400 m. Within 1100 m it sets up an induced explosion safety circuit; it is generally sensitive beyond 2500 m.

SEA BOTTOM SWEEPING GEAR, MODEL I

Object: This net is towed between two small ships. When the net catches a mine (which is on the sea bottom), the mine is removed and rendered ineffective.

## MAIN ITEMS OF OUTFIT

Items See Figure 13(B)	No/Set	Details
A Towing wire	2	diam-12mm, length-50 m
B Side wire	4	diam-10mm, length-50 m
C Top wire	1	diam-10mm, length-200 m
D Bottom wire	1	diam-10mm, length-200 m
E Net	10	wire diam-4mm, width-20 m length-10 m
F Vertical net	11	diam-8mm, length-10 m

ENCLOSURE (B), continued

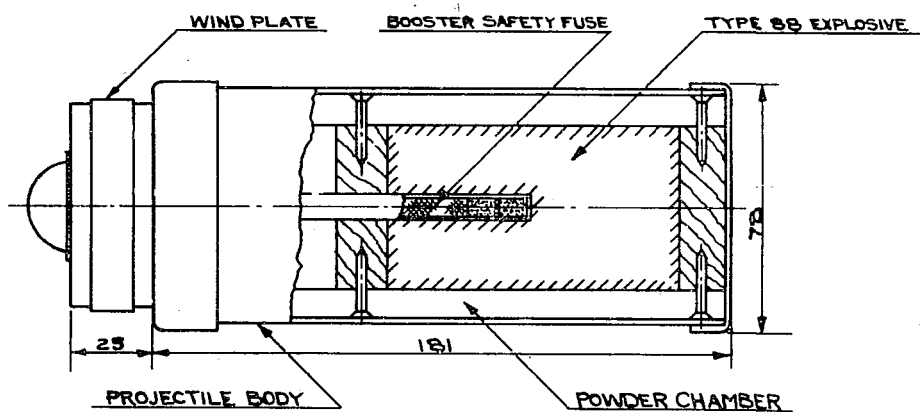

Figure 12(B)  
MARK IV SOUND PROJECTILE

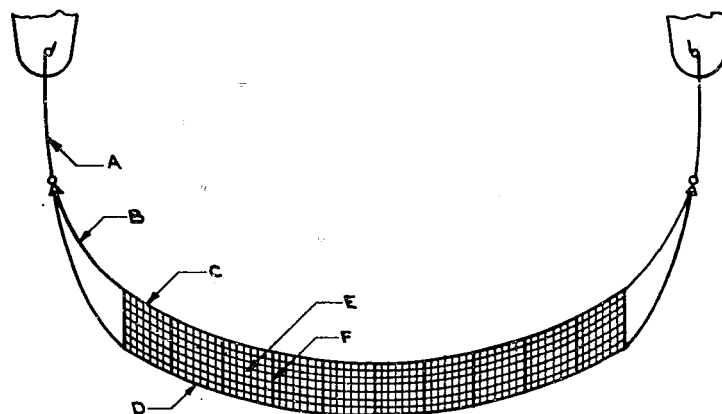

Figure 13(B)  
SEA BOTTOM SWEEPING GEAR, MODEL 1

## ENCLOSURE (B), continued

UNDERWATER DISPOSAL DEVICE, MODEL 1

Object: This gear is towed by either one or two boats. When the gear catches the mooring of a mine (or an antisweeper), the mooring is blasted by the blasting explosives.

History: This was experimentally constructed and tested at the Mine Experiment Department in May 1935.

## MAIN ITEMS OF OUTFIT

Items See Figure 14(B)		No/Set	Details
A	Towing wire	2	diam-9mm, length-180 m, steel wire rope Mark 4, "S" and "Z" strand
B	Blasting explosive	1	
C	Shackle	2	diam-10mm
D	Buoy wire	3	diam-8mm, steel wire rope Mark 4, length (10 m) -2, length (5 m) -1
E	Buoy		buoyancy - 60 kg, for pairs - 1; for single - 1
F	Cable	1	ignition cable Mark 2, diam-10.8mm, length 250 m

EXPLOSIVE HOOK MARK 2, MODEL 1

Object: Used together with blasting gear.

## MAIN ITEMS OF OUTFIT

Items See Figure 15(B)		Details
A	Total length	632mm
B	Drum diameter	200mm
C	Drum length	250mm
D	Drum plate	thickness - 2.3mm
	Drum weight	empty...0 kg full...13 kg
	Powder volume	7.2 liter
E	Powder	Type 88 powder-7 kg
	Firing system	electric
F	Fuse	mine electric fuse

ENCLOSURE (B), continued

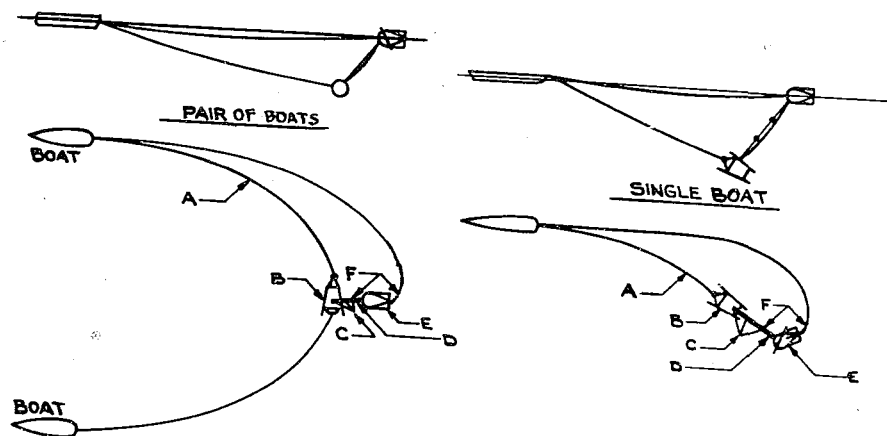

Figure 14(B)  
UNDERWATER DISPOSAL DEVICE, MODEL 1

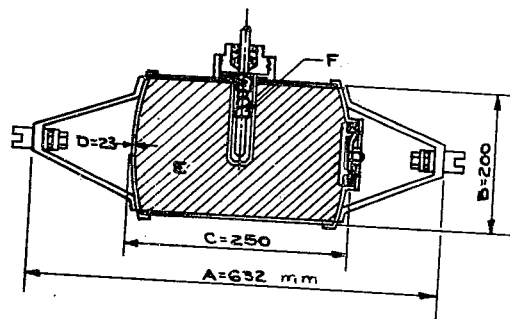

Figure 15(B)  
EXPLOSIVE HOOK, MARK 2 MODEL 1

## ENCLOSURE (B), continued

DEEP SEA SEARCH GEAR, MODEL 1

Object: This is a simple bottom sweep and is towed by a single boat. It is able to catch cables which are laid on the sea bottom.

History: This was experimentally constructed and tested at the Mine Experiment Department in 1932 in accordance with Fleet Headquarters Order.

Former name: Special Bottom Sweep (50 kg)

## MAIN ITEMS OF OUTFIT

	Items See Figure 16(B)	No/Set	Details
A	Tow wire	2	16mm steel wire Mark 4, length-100 m
B	Shackle	5	
C	Swivel and Shackle	3	
D	Chain		length-10 m
E	Anchor	1	weight-50 m
F	Weight	2	weight-20 m

SUBMERGED ELECTRIC CUTTING GEAR, MODEL 2

Object: This is a simple bottom sweep and is towed by a single boat. It is able to catch cables laid on the sea bottom.

History: It was first manufactured in December 1916.

Former name: Bottom Sweeping Gear.

## MAIN ITEMS OF OUTFIT

	Items See Figure 17(B)	No/Set	Details
A	Anchor	1	diam-20mm, length-180 m
B	Anchor	1	diam-20mm, length-180 m
C	Anchor	1	diam-20mm, length-140 m
D	Anchor	1	diam-20mm, length-50 m
E	Safety	6	diam-10mm, length-1 m
F	Side wire	1	diam-20mm, length-20 m
G	Buoy rope	1	diam-20mm, length-150 m, Manila rope
H	Buoy	1	buoyancy-190 kg, weight-53.5 kg
I	Tension meter	1	8 ton (oil pressure type)

ENCLOSURE (B), continued

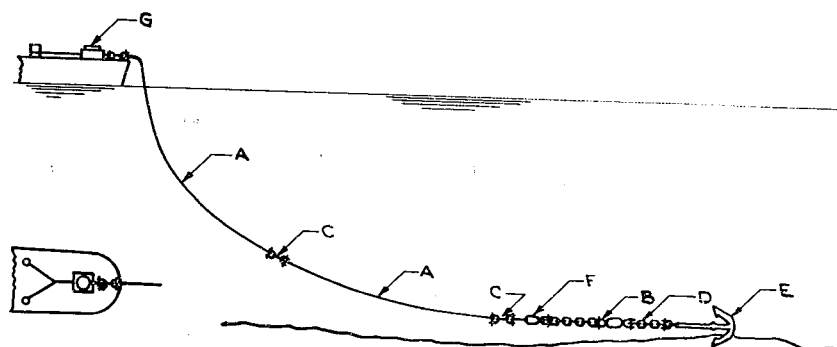

Figure 16(i)  
DEEP SEA SEARCH GEAR, MODEL 1

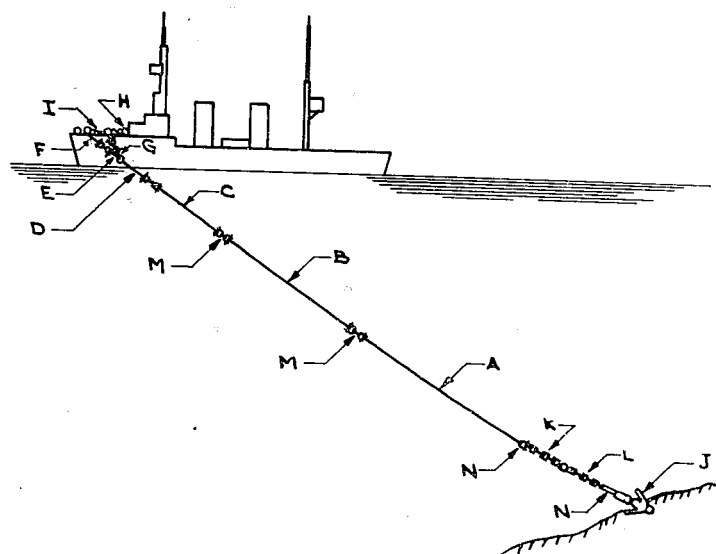

Figure 17(B)  
SUBMERGED ELECTRIC LINE CUTTING GEAR



## ENCLOSURE (B), continued

## MAIN ITEMS OF OUTFIT (Cont.)

	Items See Figure 17(B)	No/Set	Details
J	Anchor		
	ordinary	1	145 kg
	ordinary	1	102 kg
	ordinary	1	23 kg
	for sand	1	98 kg
	for rock	1	145 kg
	for slime	1	227 kg
	for cutting	1	?
K	Chain	1	diam-19mm, length-10 m
L	Chain	1	diam-19mm, length-20 m
M	Shackle	5	
N	Shackle	7	
O	Ring	11	

LARGE PARAVANING GEAR (Formerly designated Model B)

Object: Large paravaning gear is used by capital ships for severing mine mooring cables.

## PRINCIPAL DATA

Item (See Figure 18(B))		Specifications
Total weight of paravanes complete (except couplings and fitted mountings)		595 kg
Paravane buoyancy		32 kg
Pitch angle of paravane fins (longitudinal)		6°
Paravane aspects when streamed	Longitudinal inclination	19.5°
	Latitudinal inclination	40°
Center of Gravity	From leading edge of device	
Center of Buoyancy		
Total length of paravane		3.577 m
Body	Maximum outer diameter	533 m
	Thickness of outer skin	4 m
Towline securing point	Aft of leading edge of paravane	406 m
	Above center axis	515 m

## ENCLOSURE (B), continued

## MAIN ITEMS OF OUTFIT (Cont.)

	Items See Figure 17(B)	No/Set	Details	
J	Anchor	ordinary	1	145 kg
		ordinary	1	102 kg
		ordinary	1	23 kg
		for sand	1	98 kg
		for rock	1	145 kg
		for slime	1	227 kg
		for cutting	1	?
K	Chain	1	diam-19mm, length-10 m	
L	Chain	1	diam-19mm, length-20 m	
M	Shackle	5		
N	Shackle	7		
O	Ring	11		

LARGE PARAVANING GEAR (Formerly designated Model B)

Object: Large paravanning gear is used by capital ships for severing mine mooring cables.

## PRINCIPAL DATA

Item (See Figure 18(B))		Specifications
Total weight of paravanes complete (except couplings and fitted mountings)		595 kg
Paravane buoyancy		32 kg
Pitch angle of paravane fins (longitudinal)		6°
Paravane aspects when streamed	Longitudinal inclination	19.5°
	Latitudinal inclination	40°
Center of Gravity	From leading edge of device	
Center of Buoyancy		
Total length of paravane		3.577 m
Body	Maximum outer diameter	533 m
	Thickness of outer skin	4 m
Towline securing point	Aft of leading edge of paravane	406 m
	Above center axis	515 m

ENCLOSURE (B), continued

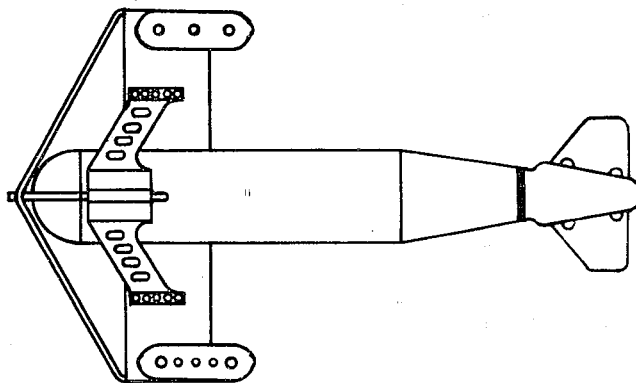

Figure 18(B)  
LARGE PARAVANE

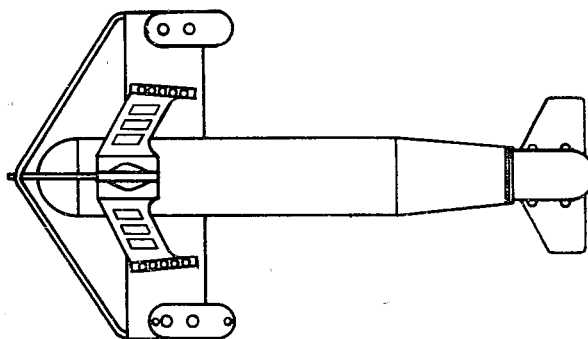

Figure 19(B)  
MEDIUM PARAVANE, MODEL 1

## ENCLOSURE (B), continued

## PRINCIPAL DATA (Cont.)

Item (See Figure 18(B))		Specifications	
Fins	Length	2.134 m	
	Width	508mm	
	Radius of pitched surface	1.676 m	
	Position	Fin leading edge is aft of paravane leading edge	628.5mm
		Fin upper leading edge is beneath paravane body center axis	357mm
Stabilizers	Length	406mm	
	Width	170mm	
Pressure Plate	Thickness of depth pressure rubber plate	4.8mm	
	Rubber plate diameter X area	132.5mm X 13789mm <sup>2</sup>	
Tow Cable	Circumference	5.4mm	
	Length	50 m	

MEDIUM PARAVANING GEAR, MODEL 1

Object: Medium Paravaning gear is towed from the bow of a cruiser with the purpose of severing mine mooring cables. (Purchased from friendly firms in England 1917.)

## PRINCIPAL DATA

Item (See Figure 19(B))		Specification
Total weight of paravane complete		453 kg
Paravane buoyancy		32 kg
Pitch angle of paravane fins		10°
Paravane aspects when streamed	Longitudinal-inclination	19.5°
	Latitudinal inclination	40°
Center of gravity	} From leading edge	1.349 m
Center of buoyancy		
Total length of paravane		1.283 m
Body	Maximum outer diameter	3.296 m
	Thickness of outer skin	470mm
		3.2mm (Nose 4mm)

## ENCLOSURE (B), continued

## PRINCIPAL DATA (Cont.)

Item (See Figure 19(B))		Specification	
Towline Securing Point	Aft of leading edge of paravane	412mm	
	Above center axis	468mm	
Length		1.905mm	
Fins	Width	457mm	
	Radius of pitched surface		1.676 m
	Position	Fin leading edge is aft of paravane leading edge	609mm
		Fin upper leading edge is beneath paravane body center axis	327mm
Stabilizer	Length	330mm	
	Width	197mm	
Pressure Plate	Thickness of depth pressure Rubber Plate	418mm	
	Rubber plate diameter X area	132.5mm X 13789mm <sup>2</sup>	
Tow Cable	Circumference	5.4mm	
	Length	50 m	

LIGHT PARAVANING GEAR

**Object:** This simple gear is chiefly towed by merchant vessels which are employed by the Navy. It catches a mine and cuts the mooring wire.

**History:** It was experimentally constructed and tested at the Mine Experiment Department in accordance with Fleet Headquarters Top Secret Order No. 3570, issued 26 September 1931.

**Date Adopted:** January 1934.

**Former name:** Mark 3 Type 1 Otter Gear.

## MAIN ITEMS OF OUTFIT

Items See Figure 20(B)	No/Set	Details
A Pendant	1	diam-12mm, length-50 m, "S" strand
B Kite	2	wooden plane: width-1.6 m, body length-2.2 m, weight-95 kg, buoyancy-25 kg
C Cutter	4	weight-15 kg
D Buoy	2	buoyancy-200 kg

## ENCLOSURE (B), continued

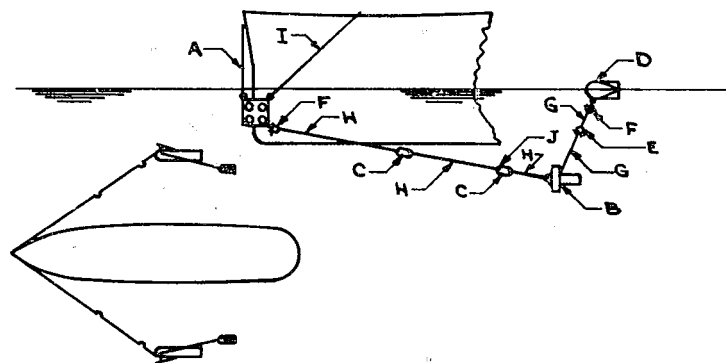

Figure 20(B)  
LIGHT PARAVANNING GEAR

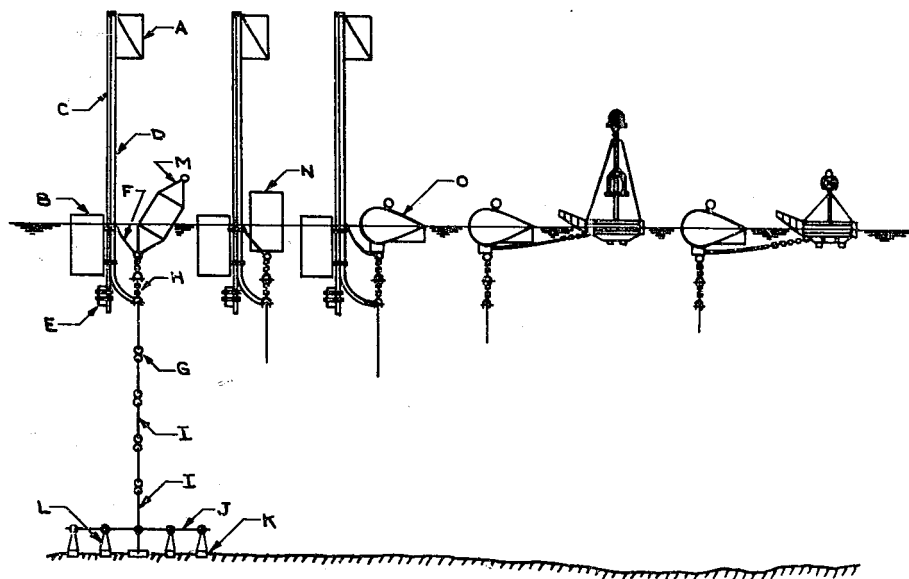

Figure 21(B)  
SWEEPING MARKERS

ENCLOSURE (B), continued

MAIN ITEMS OF OUTFIT (Cont.)

Items See Figure 20(B)	No/Set	Details
E Shackle	2	diam-26mm
F Swivel and shackle	12	diam-26mm
G Depth wire	4	diam-9mm length: (10 m)-2 (5 m)-2
H Tow wire	6	diam-14mm, length-40 m, 30 m and 3 m, "S" and "Z" strand, diam-10 m, length-70 m
I Stretch	2	diam-10mm, length-70 m
J Connector	4	

Operational Data:

Depth of sweep ..... 10 - 15 m  
 Actual speed ..... 8 kts  
 Spread of sweep ..... 50 - 55 m  
 Tension ..... 1.2 ton

SWEEPING MARKERS

MAIN ITEMS OF OUTFIT

Items See Figure 21(B)	No/Set	Details
A Flag	1	width-1.220 m, length-1.530 m
B Buoy	1	diam-290mm, length-590mm, buoyancy-30 kg, weight-9.9 kg
C Pole	1	diam-150mm, length-7 m
D Picking-up rope		diam-78.5mm, length-8 m, tarred rope
E Weight	3	diam-123mm, weight-20 kg, diam-90mm, weight-10 kg, diam-67mm, weight-5 kg
F Connecting wire	1	diam-25mm, length-2 m
G Shackle	13	diam-13mm
H Chain	2	diam-9.5mm
I Depth wire	5	diam-25mm, length-20 m
J Weight connecting wire	4	diam-4.4mm, length-1 m
K Weight		
L Weight pendant		

## ENCLOSURE (B), continued

## MAIN ITEMS OF OUTFIT (Cont.)

Items See Figure 20(B)	No/Set	Details
E Shackle	2	diam-26mm
F Swivel and shackle	12	diam-26mm
G Depth wire	4	diam-9mm length: (10 m)-2 (5 m)-2
H Tow wire	6	diam-14mm, length-40 m, 30 m and 3 m, "S" and "Z" strand, diam-10 m, length-70 m
I Stretch	2	diam-10mm, length-70 m
J Connector	4	

## Operational Data:

Depth of sweep ..... 10 - 15 m  
 Actual speed ..... 8 kts  
 Spread of sweep ..... 50 - 55 m  
 Tension ..... 1.2 ton

SWEEPING MARKERS

## MAIN ITEMS OF OUTFIT

Items See Figure 21(B)	No/Set	Details
A Flag	1	width-1.220 m, length-1.530 m
B Buoy	1	diam-290mm, length-590mm, buoyancy-30 kg, weight-9.9 kg
C Pole	1	diam-150mm, length-7 m
D Picking-up rope		diam-78.5mm, length-8 m, tarred rope
E Weight	3	diam-123mm, weight-20 kg, diam-90mm, weight-10 kg, diam-67mm, weight-5 kg
F Connecting wire	1	diam-25mm, length-2 m
G Shackle	13	diam-13mm
H Chain	2	diam-9.5mm
I Depth wire	5	diam-25mm, length-20 m
J Weight connecting wire	4	diam-44mm, length-1 m
K Weight		
L Weight pendant		



ENCLOSURE (B), continued

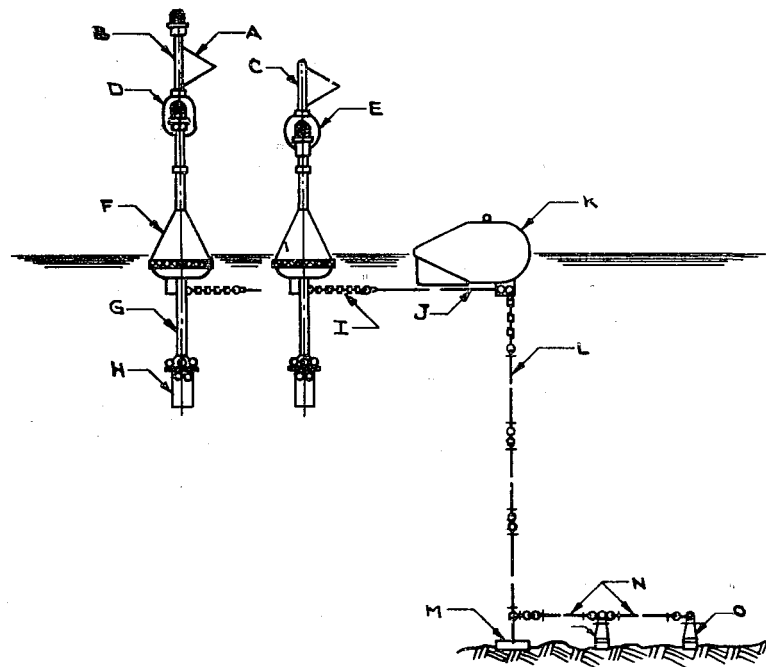
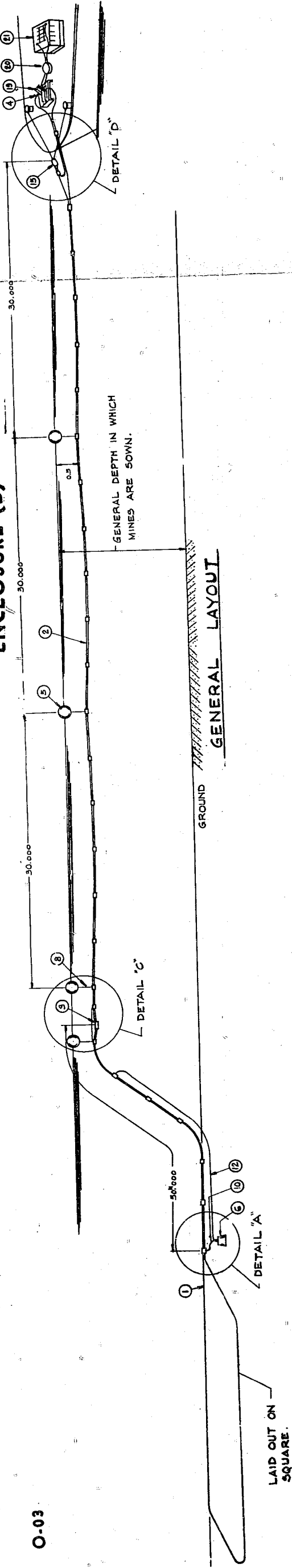

Figure 22(B)  
SWEEPING MARKER LIGHTS

ENCLOSURE (D)



GENERAL LAYOUT

LAI D OUT ON SQUARE.

DETAIL 'D'

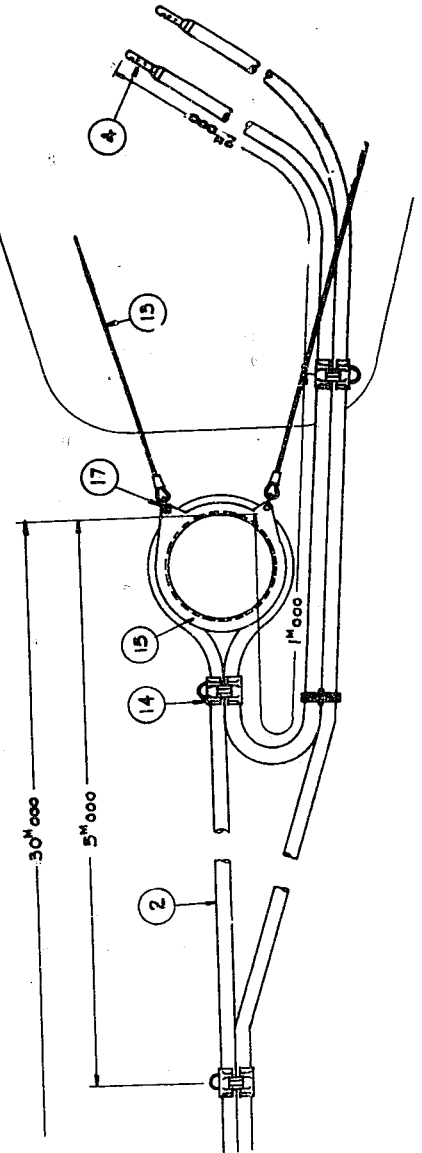

LIST OF PARTS TYPE 4 SWEEP GEAR

No.	Item
1	Conductor Cable
2	Disposal Elev. Cable
3	Harrying Bond or Cable
4	Power Terminal
5	Large Buoy 100 kg
6	Large Weight
7	Small Weight
8	Buoy Cable Short
9	Buoy Cable Long
10	Anchor Cable
11	Connecting Cable
12	Lat. Middle Cable
13	Lat. End Cable
14	Harrying Clamp for Elev. Cable
15	Holding Ring for Electric Cable
16	Iron Shackle Large
17	Iron Shackle Small
18	Tying Cable
19	Circuit Switch
20	Amperer
21	Tools
22	Tools and Toolbag
23	Accessories

DETAIL 'A'

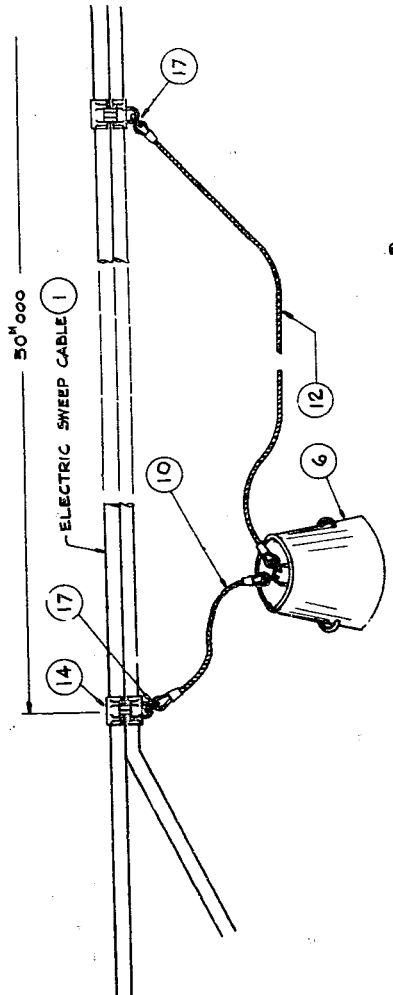

DETAIL 'C'

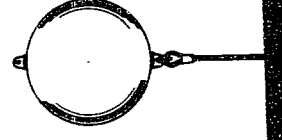
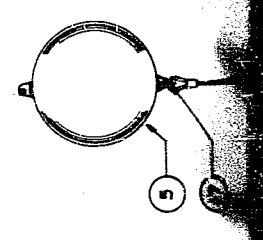
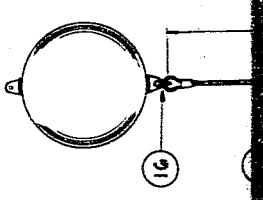

DETAIL 'B'

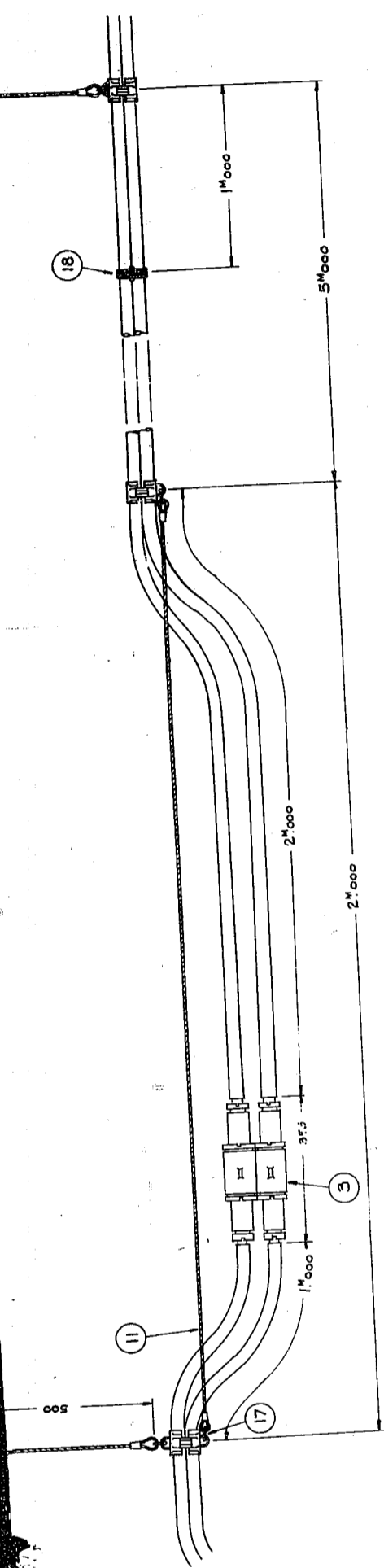
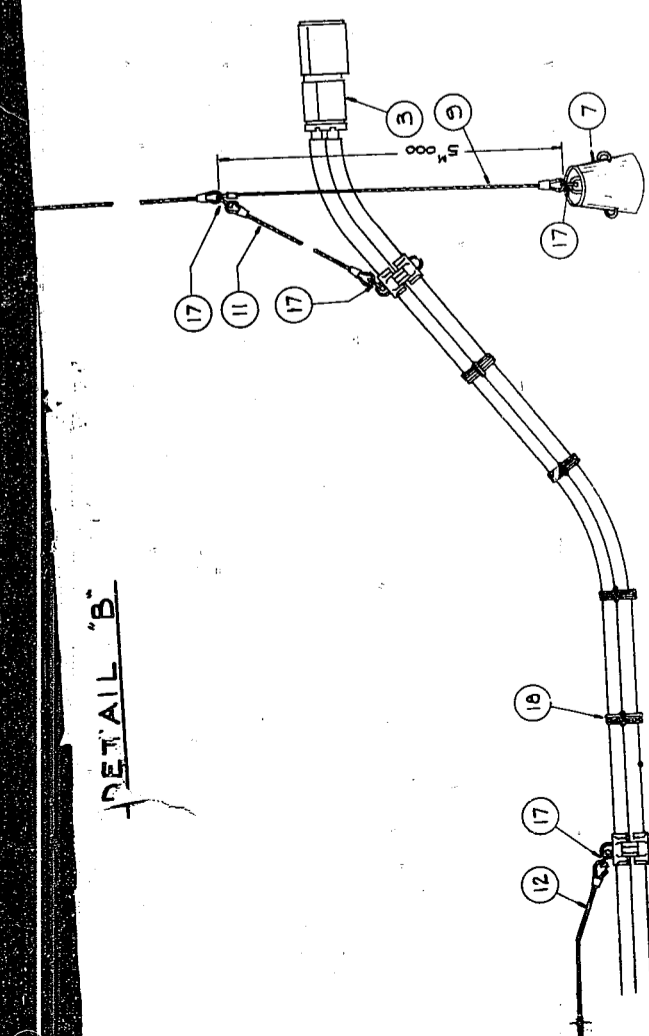

TEMPORARILY DESIGNATED TYPE 4 SWEEP GEAR

ENCLOSURE (C)

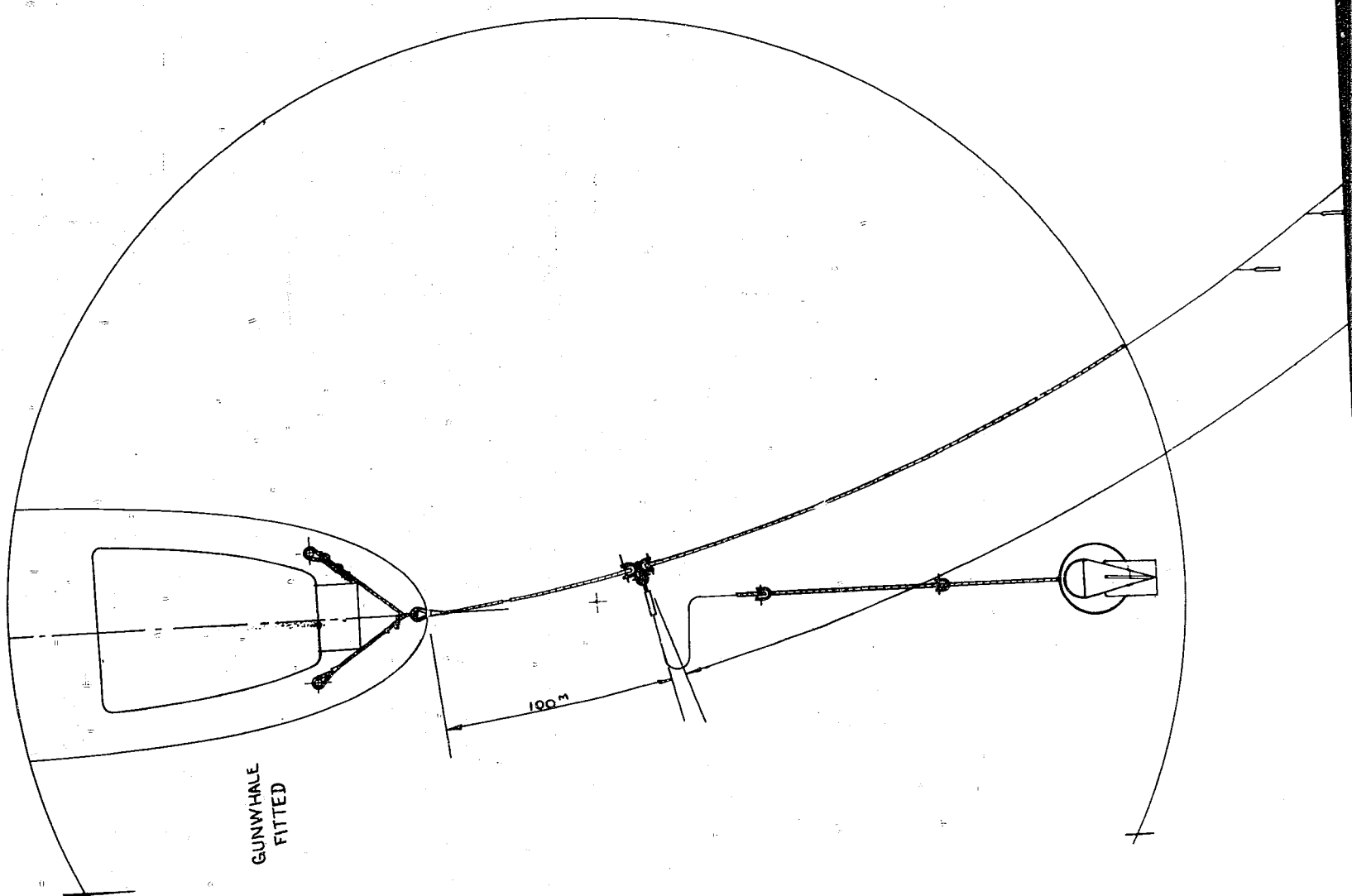
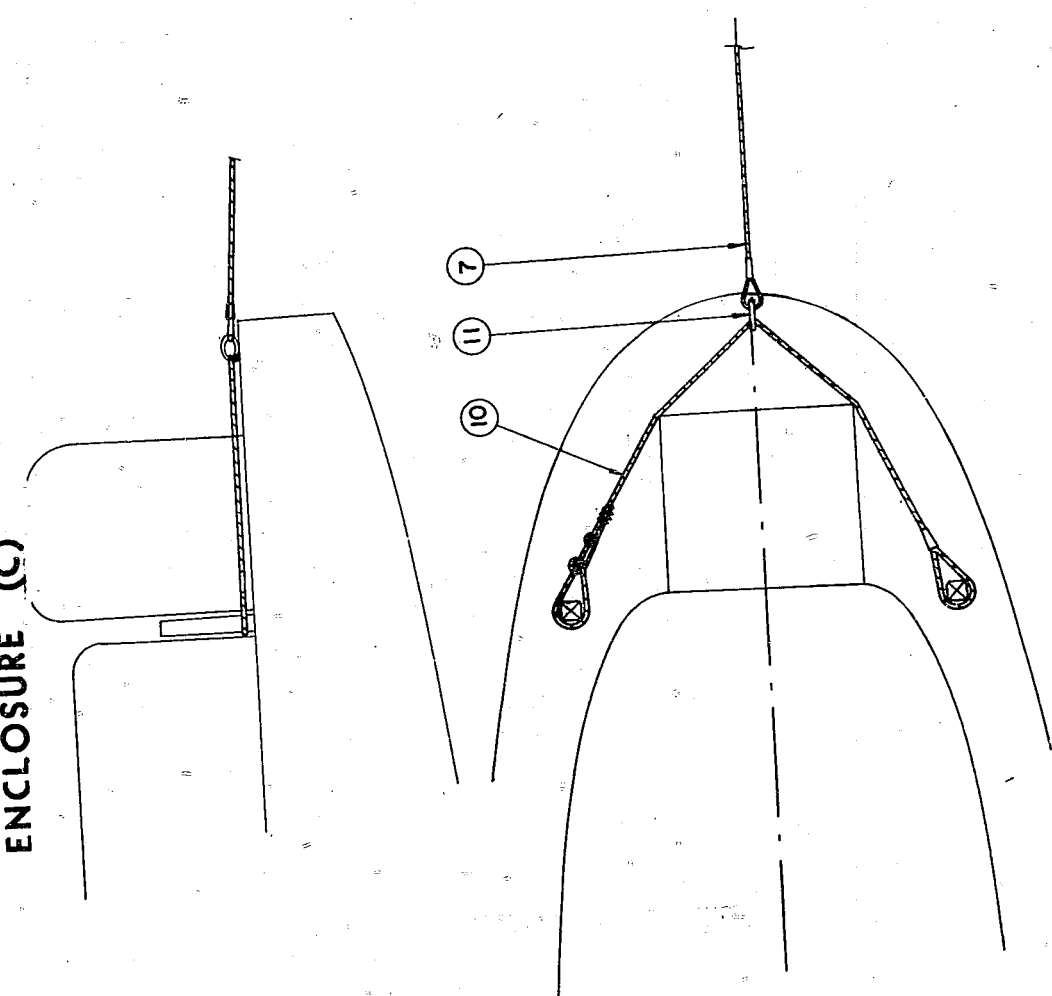
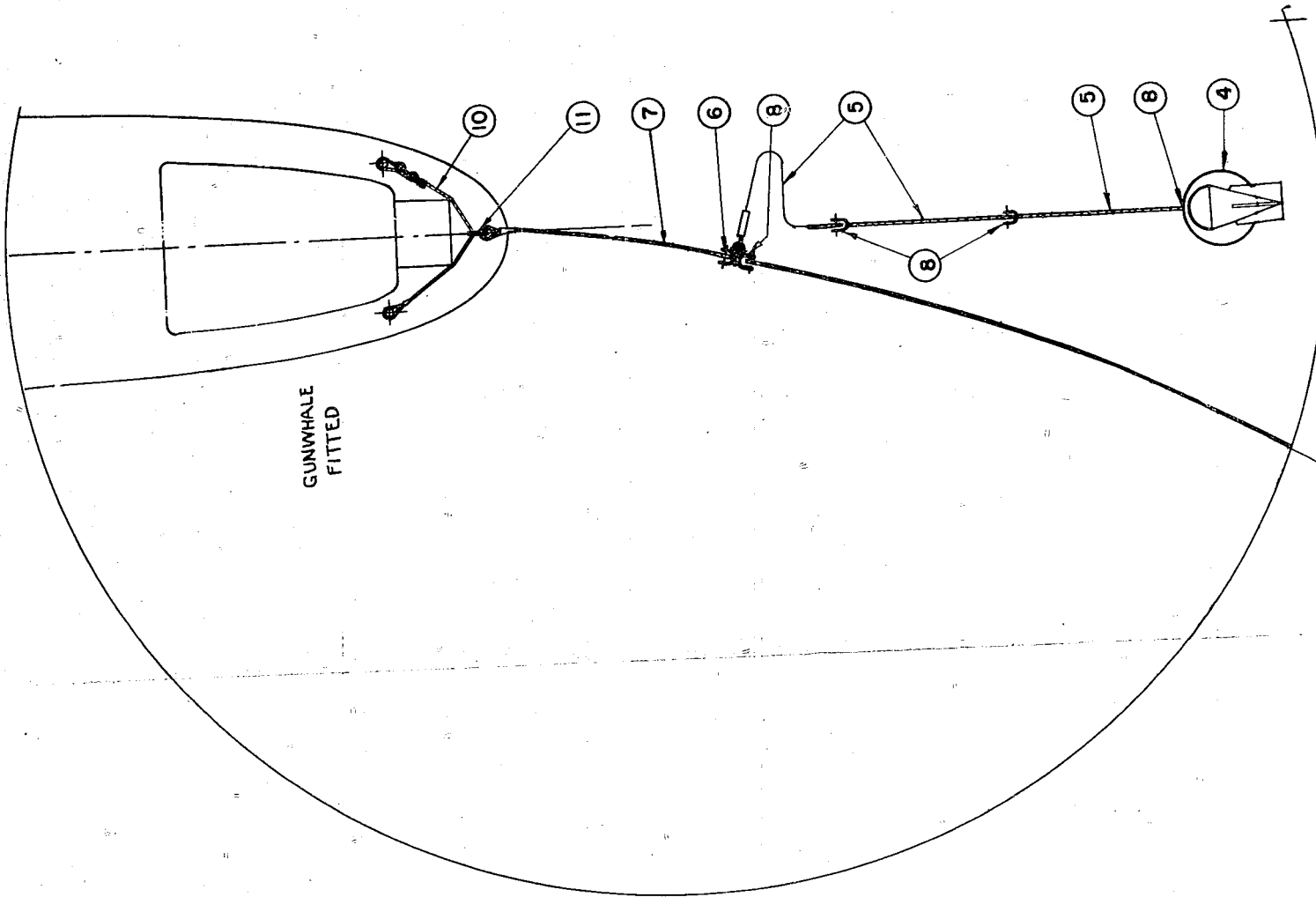

RESTRICTED

LIST OF PARTS TYPE 3 SWEEP GEAR (MODEL 2)

No.	Item
1	Magnetic Rod
2	Suspension Cable for Rod
3	Sweep Cable
4	25 KG Buoy (Wt. Attached)
5	Buoy Cable
6	Rosary Shackle
7	Shackle
8	Cable Release
9	Lead Cable
10	Shackle
11	Shackle

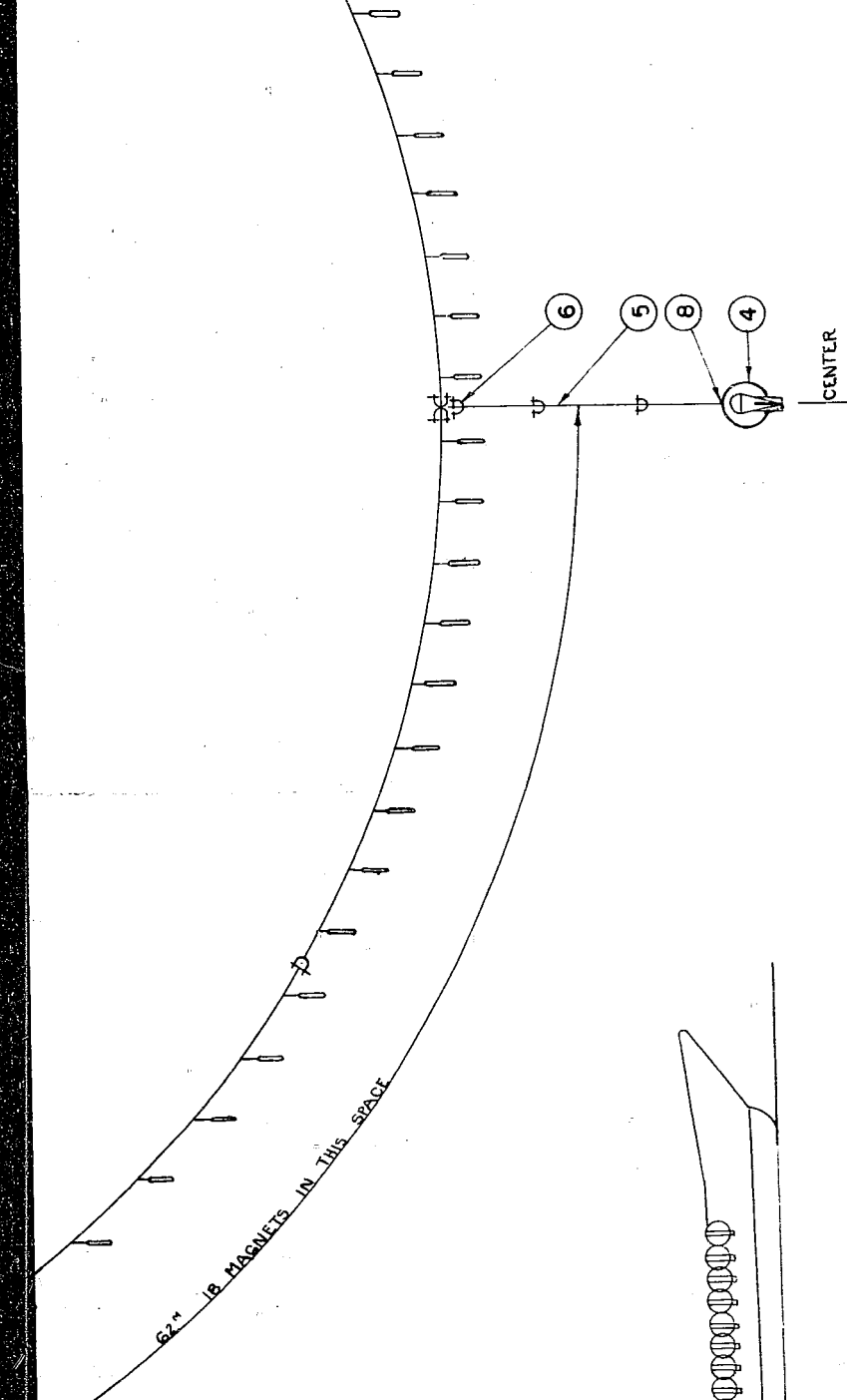
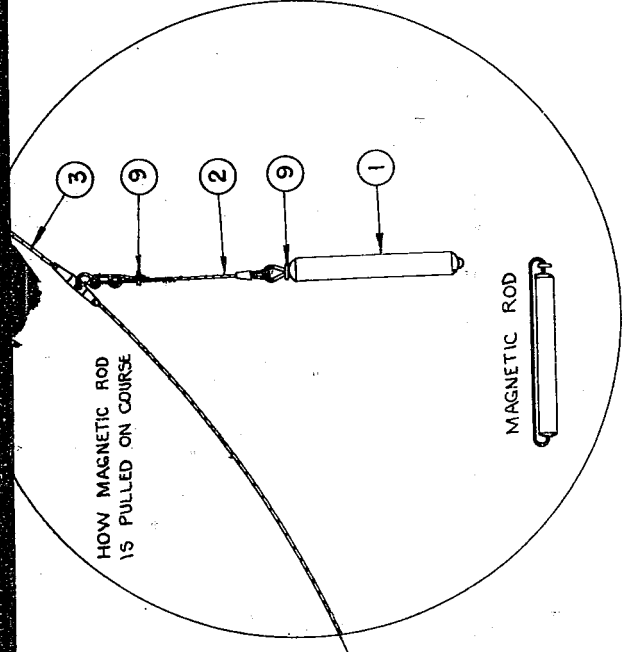

TYPE 3 SWEEP GEAR, MODEL 2

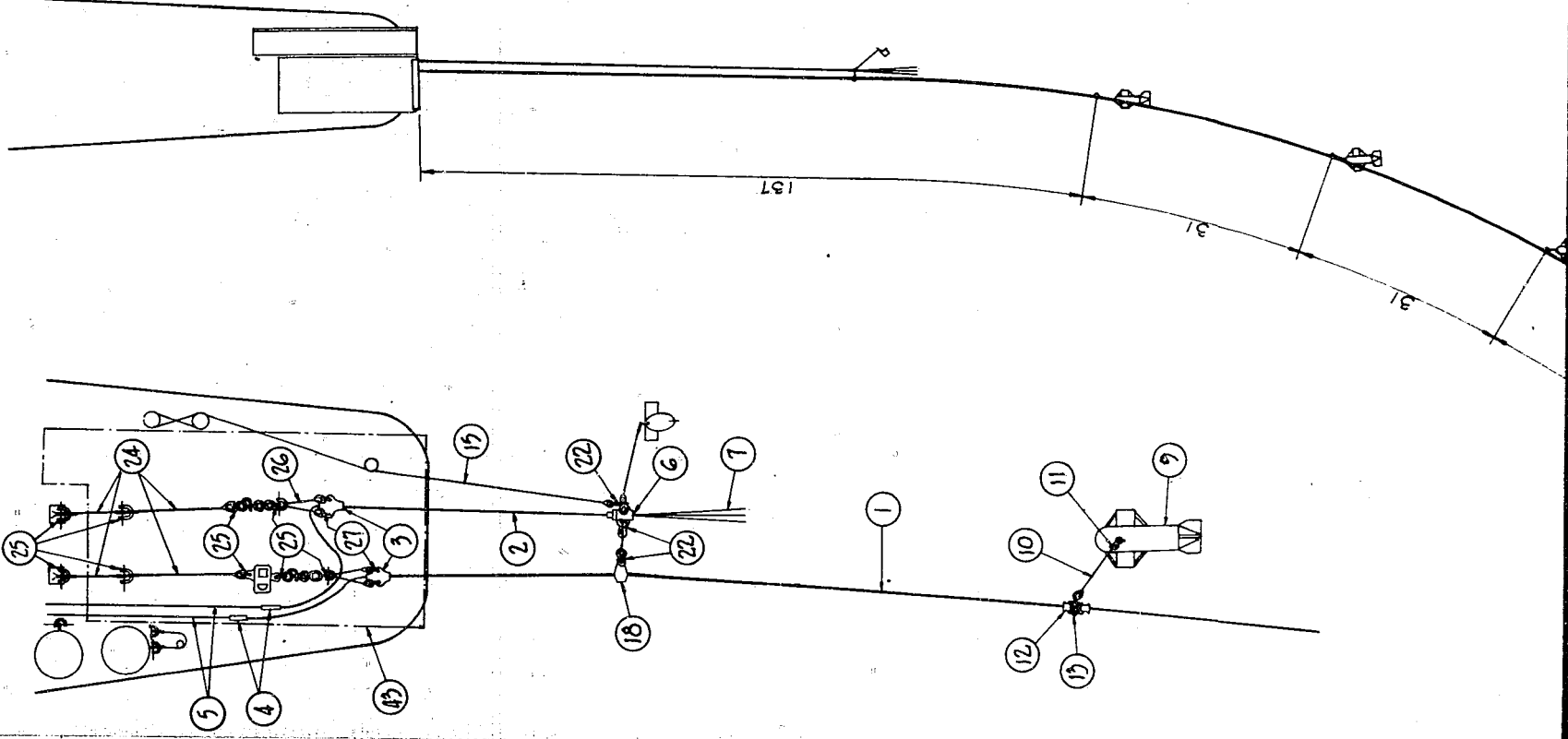
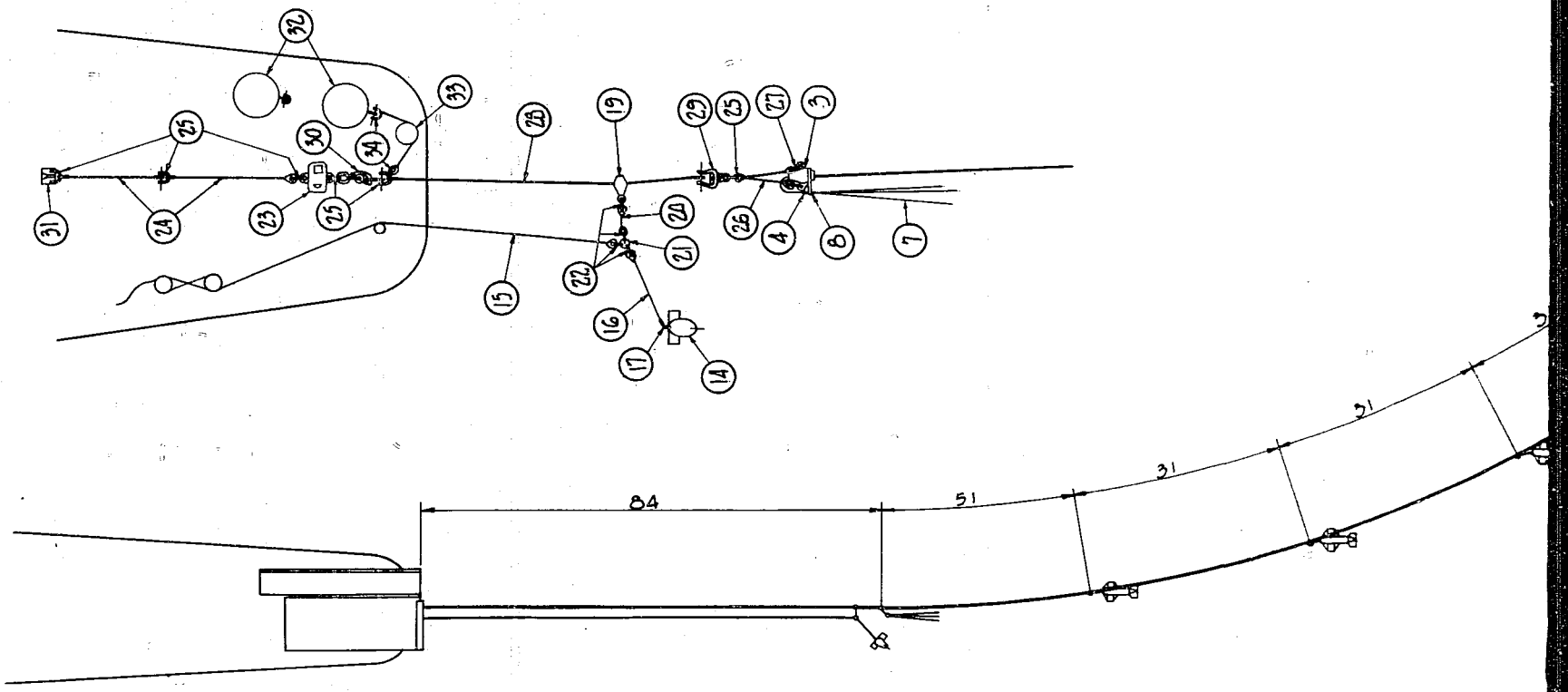

LIST OF PARTS TYPE 2 MODEL 1 SWEEP GEAR

No.	Item	No.	Item
1	Electric Sweep Cable	24	Tools
2	Magnetic Cable	25	Tools
3	Terminal Box, With Short Lead	26	Terminal Box Connecting Cables
4	Lead Connecting Screw	27	Shackle
5	Long Lead	28	Sweep Bridle Cable
6	Terminal Box, With Terminal Ground Resistance Terminal	29	Shackle With Rotary (Retaining Bells Attached)
7	Terminal Box Handle (Lever)	30	Guide Cable - Lows
8	Adjust Depth Buoy	31	200 Kg Buoy
9	Buoy Cable	32	Buoy Cable
10	Shackle, Rotary (Switch) Attached	33	Shackle
11	Lead Protective Cylinder	34	Painter
12	Suspension Shackle	35	Tools
13	Submerging Gear, Mod 1	36	Tool Box
14	Submerging Gear Weight Cable	37	Spare Parts
15	Submerging Gear Connector	38	Spare Parts Box
16	Running Block (For Lead)	39	Repair Tools
17	Running Block (For Steel Cable)	40	Repair Tool Box
18	Three Eye Plate	41	Equipping Platform
19	Painter	42	Lift Roller
20		43	Rails
21		44	Rail Ties
22		45	
23		46	

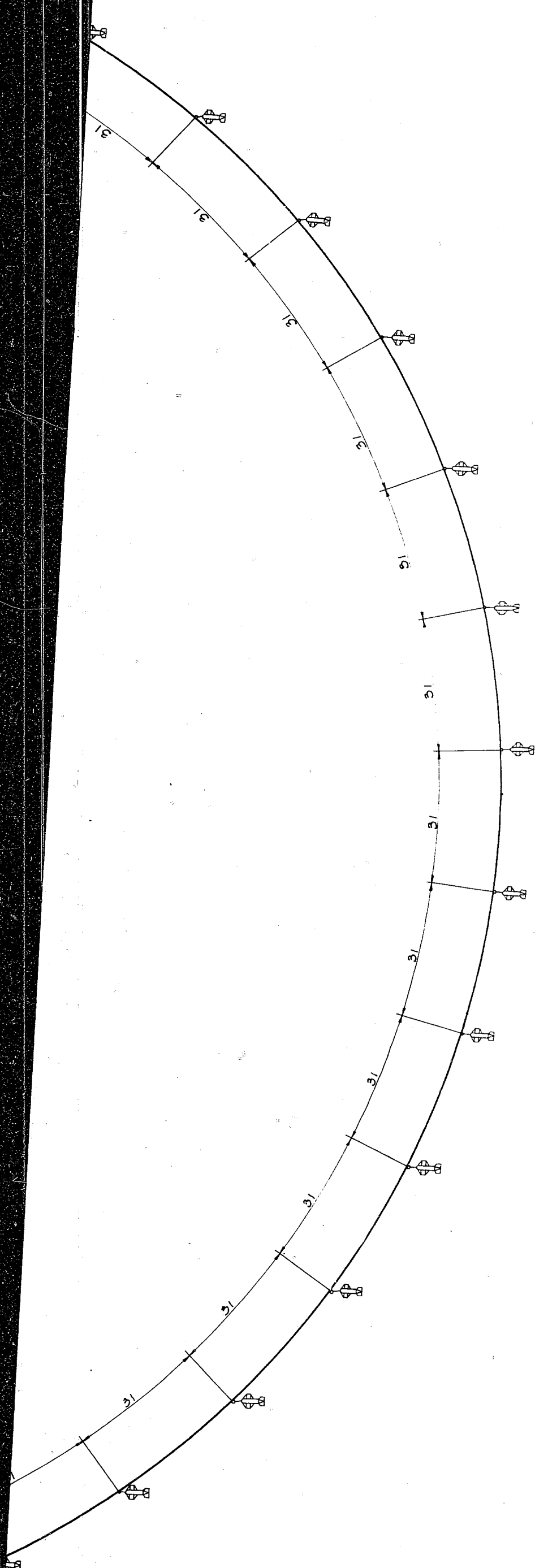

TYPE 2 SWEEP GEAR, MODEL 1

ENCLOSURE (F)

RESTRICTED

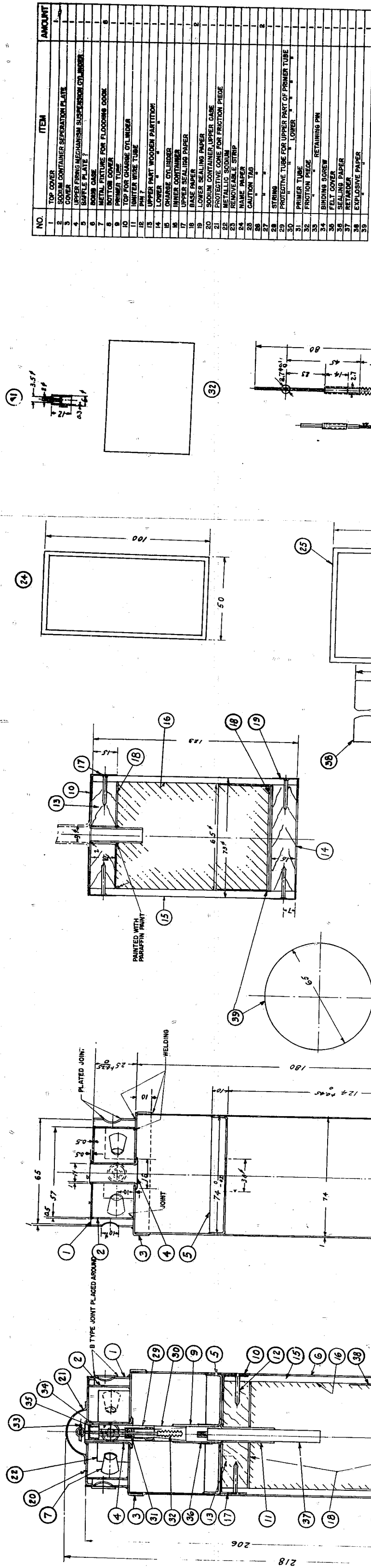

NO.	ITEM	AMOUNT
1	TOP COVER	1
2	SODIUM CONTAINER SEPARATION PLATE	1
3	COVER	1
4	UPPER FIRING MECHANISM SUSPENSION CYLINDER	1
5	UPPER PLATE 7	1
6	SOFT GUNSE	1
7	PRIMER TUBE FOR FLOODING DOCK	1
8	PRIMER TUBE	1
9	TOP FOR CHARGE CYLINDER	1
10	PRIMER TUBE	1
11	PRIMER WIRE TUBE	1
12	UPPER PART WOODEN PARTITION	1
13	LOWER	1
14	CHARGE CYLINDER	1
15	INNER CONTAINER	1
16	UPPER SEALING PAPER	1
17	BASE PAPER	1
18	LOWER SEALING PAPER	1
19	SODIUM CONTAINER UPPER CASE	1
20	PROTECTIVE CONE FOR FRICTION PIECE	1
21	METALLIC SODIUM	1
22	REMOVABLE STRIP	1
23	WIRE PAPER	1
24	GAUGE	1
25	STRING	1
26	PROTECTIVE TUBE FOR UPPER PART OF PRIMER TUBE	1
27	PRIMER TUBE	1
28	FRICTION PIECE	1
29	RETAINING PIN	1
30	BINDING SCREW	1
31	FELT COVER	1
32	SEALING PAPER	1
33	RETAINER	1
34	EXPLOSIVE PAPER	1

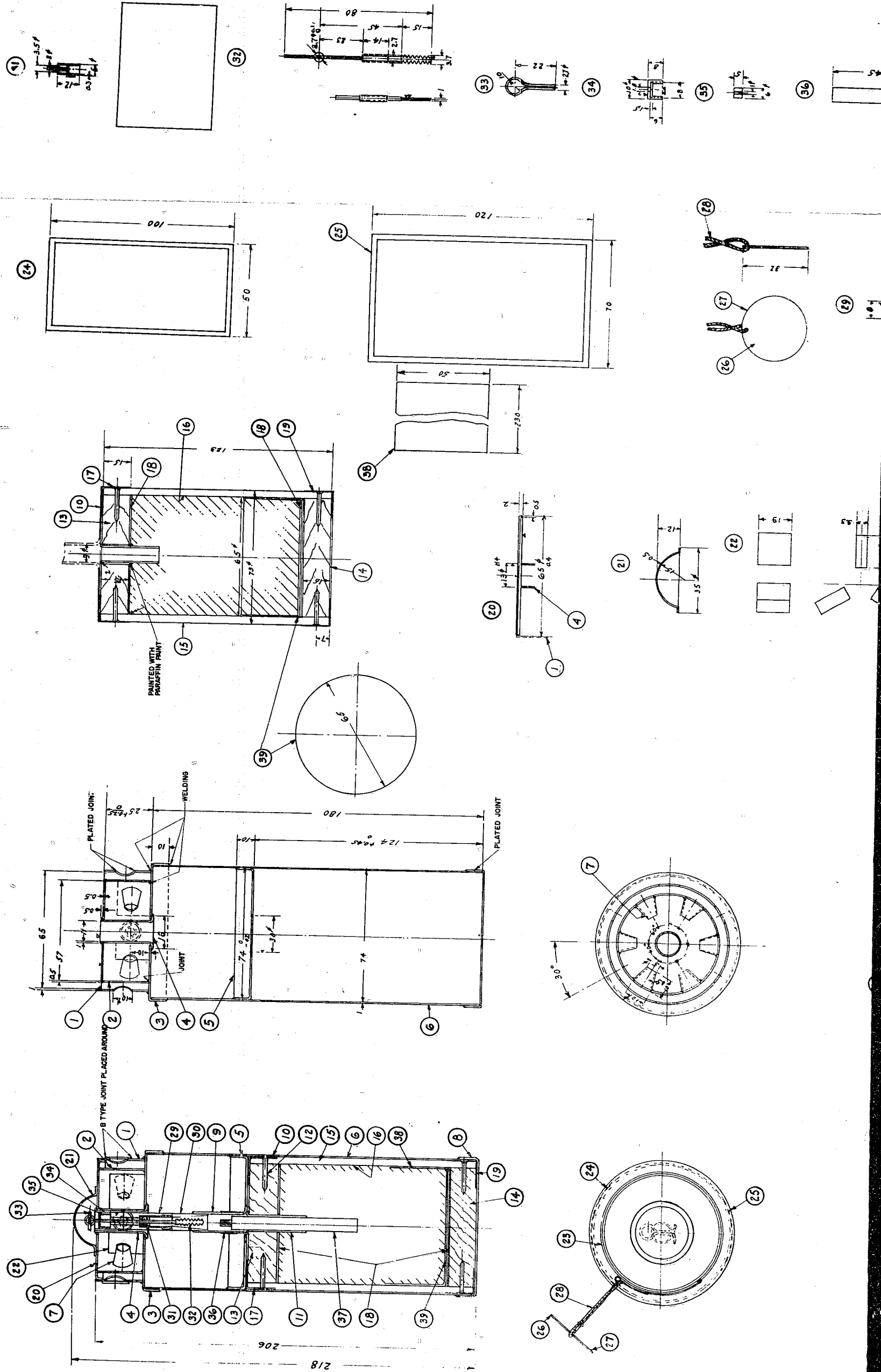



MARK 4 "UNDERWATER NOISE MAKER"

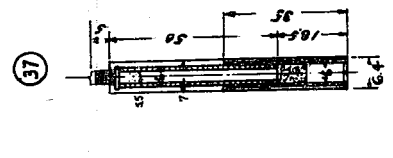
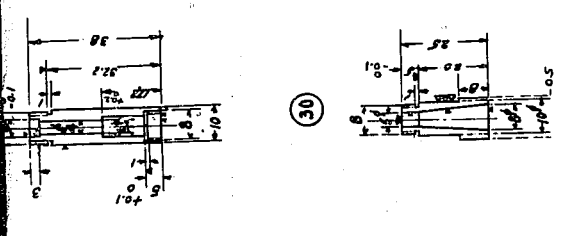
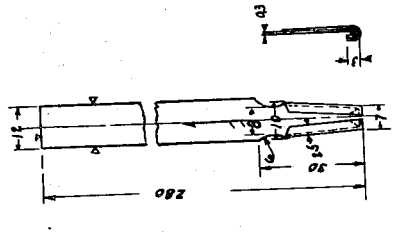
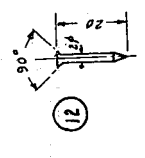
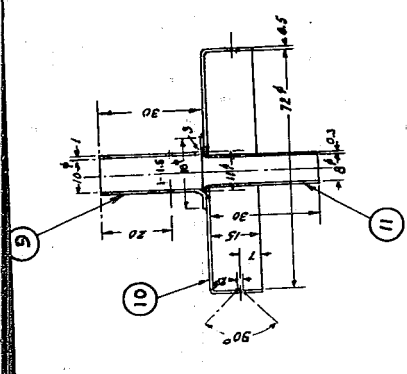
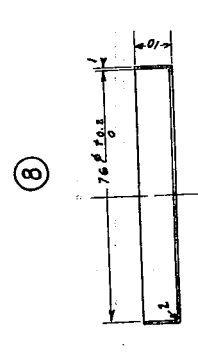

MARK 4 SOUND BOMB

## ENCLOSURE (G)

NUMBER AND TYPES OF JAPANESE VESSELS USED DURING THE WAR  
FOR SWEEPING OPERATIONS

## FOR SWEEPING JAPANESE MINES

		Escort		Minesweeper		Minelayer		Converted Minesweeper		
		Name	No.	Name	No.	Name	No.	Name	No.	Total
Ominato Minor Naval Station	Ominato defense corps	Kozu. Kurahashi Yashiro No.49	4	NO.23 NO.102	2	Niizaki	1	#3Keijinmaru #5Keijinmaru #7Fukusimaru Fujimaru	4	11
	Soya defense corps					Ashizaki	1			1
Yokosuka Naval Station	Yokosuka defense corps					Kyosai Ishizaki Kamizima	3	#1Keijinmaru #2Keijinmaru	2	5
	Ise defense corps									
	Onagawa defense corps									
	Yokohama harbor activities									
Maizuru Naval Station	Maizuru defense corps					Washizaki	1			1
	Niigata harbor activities									
	Fushiki harbor activities									
	Tsuruga harbor activities									
	Nanao harbor activities									
	Sakata harbor									
	Sakai harbor corps									
Osaka Minor Naval Station	Kii defense corps	No.104 No.154	2					#3Senyumaru Sakakimaru Attumaru Taka shima-maru	4	6
	Osaka harbor activities									
	Kobe harbor activities									

## ENCLOSURE (G), continued

## FOR SWEEPING AMERICAN MINES (Magnetic Mines, etc.)

		Auxiliary Submarine Chaser(Wooden)		Light Patrol		Auxiliary Minesweeper		Dai-hatsu	Fisher boat	Total	Grand total
		Name	No.	Name	No.	Name	No.				
Ominato Minor Naval Station	Ominato defense corps	No.58(damaged severely) No.65 No. 193 No.72 No. 196 No.78 No. 203 No.81 No. 222 No.112	9 (1)						13	22(1)	33(1)
	Soya defense corps					No.17 No.18	2			2	3
Yokosuka Naval Station	Yokosuka defense corps	No.213 No.1 No.180 No.27 No.182 No.68 No.155 No.159 (unmovable) No.211(damaged)	6 (2)	No.26 No.54 No.110 No.122 No.165	5	No.11 No.12 No.13 No.14	4			15 (2)	20 (2)
	Ise defense-corps										
	Onagawa defense corps	No.88 No.161 No.171	3							3	3
	Yokohama harbor activities			No.2 No.3	2					2	2
Maizuru Naval Station	Maizuru defense corps	No.57 No.89 No.157 No.166 No.184 No.218(unmovable) No.219(unmovable)	5 (2)			No.19 No.20	2		25	32 (2)	33 (2)
	Miigata harbor activities	No.153 (damaged unmovable) No.236	1 (1)	No.84 No.90	2				10	13 (1)	13 (1)
	Fushiki harbor activities	No.181	1						12	13	13
	Tsuruga harbor activities								12	12	12
	Nanao harbor activities	No.162	1	No.163(damaged)	(1)				4	5 (1)	5 (1)
	Sakata harbor								2	2	2
Sakai harbor								3	3	3	
Osaka Minor Naval Station	Kii defense corps	No.21 No.22 No.241	3			No.21 No.22	2	10	20	35	41
	Osaka harbor activities							4	11	15	15
	Kobe harbor activities	No.20 (damaged)	(1)					4	12	16 (1)	16 (1)

## FOR SWEEPING JAPANESE MINES (Cont.)

		Escort		Minesweeper		Minelayer		Converted Sweeper		
		Name	No.	Name	No.	Name	No.	Name	No.	To.
Kure Naval Station	Saaki defense corps	No.48 No.76 No.77 No.102 No.156 No.217	6			Nuwajima Kurokami	3			9
	Kure defense corps							Aoimaru #10Tokino-maru Kozanaru Yachiyo-maru	4	4
	Tokuyama defense corps									
	Senzaki harbor activities									
Seventh Fleet	Shimonoseki defense corps							#5Tokuhomaru Miyomaru #5Kirimaru #2Asashimaru Bisanmaru	5	5
	Moji harbor activities									
	Taushima Naval-Guard									
Sasebo Naval Station	Sasebo defense corps	Shinnan Ikuna Shiga Daito Ukuru Chikubu	6	No.17	1			#8Chounmaru	1	8
	Kyushu area					Saishu (Kagoshima)	1			1
Chinkai Minor Naval Station	Chinkai defense corps	No.12 No.22 No.26 No.40	4			Kuroshima Katoku	2	Taiseimaru	1	7
	Genzan									
	Rashin harbor activities							#3Taiseimaru	1	1
Takao Naval Station	Takao activities					Ento	1			1
	Kiirun harbor activities									
Total			22		3		13		22	60

Remarks: (a) Number in parenthesis show number of damaged sweepers.  
(b) Escort on this table is organized well for sweeping.

## ENCLOSURE (G), continued

## FOR SWEEPING AMERICAN MINES (Magnetic Mines, etc.) (Cont'd)

		Auxiliary Submarine Chaser (Wooden)		Light Patrol		Auxiliary Minesweeper		Dai- hatsu	Fisher boat	Total	Grand total
		Name	No.	Name	No.	Name	No.				
Kure Naval Station	Saeki defense corps			No.136 No.137 No.175	3					3	12
	Kure defense corps	No.221 No.229 No.25 No.69 No.170 (damaged slightly) No.175 No.198 (damaged slightly)	3 (4)	No.31 (unmovable) No.102 No.138 No.191 (unmovable)	2 (2)				25	30 (6)	34 (6)
	Tokuyama defense corps	No.174 No.215	1 (1)	No.135	1				15	17 (1)	17 (1)
	Senzaki harbor activities	No.187 No.222	2	No.179	1				8	11	11
Seventh Fleet	Shimonoseki defense corps	No.239 No. 245 No.108 No.214 No.60 No.217 No.246 No.232 No.160 No.178 (damaged severely) No.179 No.186 No.208	7 (6)	No.153  No.152	2			17	12	38 (6)	43 (6)
	Moji harbor activities	No.226 (damaged)	(1)						12	12 (1)	12 (1)
	Tsushima Naval Guard	No.71 No.248 No.249 No.250	4							4	4
Sasebo Naval Station	Sasebo defense corps	No.169 No.228	2	No.176	1					3	11
	Kyushu area	No.234 No.201 No.90 No.231 No.99 No.154 No.158 No.168 No.173	9							9	10
Chinkai Minor Naval Station	Chinkai defense corps	No.79 No.80 No.86 No.93 No.100 No.247	6			No.15 No.16	2			8	15
	Genzan Rashin harbor activities	No.242	1							1	1
Takao Naval Station	Takao activities	No.190	1							1	2
	Kiirun harbor activities	No.74 No.75 No.223 No.238 No.243	4 (1)							4 (1)	4 (1)
			69 (20)		19 (3)		19	35	198	133 (23)	263 (27)

## ENCLOSURE (H)

## JAPANESE REPORT ON U.S. MINES SWEEP

Area	Number of American Laid Mines					Number of Mines Disposed						No. Disposed No. Laid x100	
	Magnetic	Acoustic	Low Freq. Acoustic	Pressure Magnetic	Total	Swept	Explosion	Initial Explosion	Touch Explosion	Laid above	Total		
Setonaikai (Inland Sea)	Shimonoseki Kannon Strait	1,410	2,134	277	1,267	4,188	310	1,089	60	214	190	1,903	45.4
	Suo-Nada	130	228	67	180	605	240			57	1	298	49.0
	Iyo-Nada East Suo-Nada	44	158	2	67	271	8	60		18		86	31.7
	Hiroshima Bay	205	329		16	590	29	72	11	11		123	22.7
	Aki-Nada	5	5		20	30	14	3				17	56.6
	Hayaori Strait	8	1		11	20	2	3				5	25.0
	Bingo-Nada Hiuchi-Nada	18	15		21	54		5	5				
	East Bingo-Nada	67	62	7	23	159	20			15		45	12.2
	West Harima-Nada	62	64	4	94	224							
	Harima-Nada	21	22		74	117				4		4	3.4
	Tsumi-Nada	230	139	6	276	651	108	56		56		220	33.7
	Kii-Channel				7	7							
	Total	2,200	2,257	363	2,056	6,876						2,700	
Japan Sea	Humakawa	52	19			71	18	16	7			31	43.0
	Sakata	59	34			93	8	21		4		33	35.5
	Hiigata	490	191	10	88	779	139	113		33	70	355	45.5
	Neosetsu	13	11			24							
	Huehigi	261	71		91	423	85	105		10	133	353	83.0
	Hanao	179	56	44	67	346	61	50		19	41	171	49.4
	Tsuruga	244	59	12	14	329	104	29		16	27	174	53.0
	Wakasa Bay	264	100	138	89	591	129	1		26	109	285	48.2
	Sakai	102	41			143	30	10		11	26	77	53.8
	Oki Ise	9	3			12							
	Hamada	37	23	49		109	4	about 17		4	15	about 40	36.7
	Senzaki	28	20	7	21	76	7	about 17		2	15	about 41	54.0
	Hagi	110	38	2	21	171	10	about 23		5	8	about 46	26.9
	Tsuy Bay	42	20	13	28	103							
	Total	1,890	686	275	419	3,270						1,367	
North Kyushu	Hakata	208	41	17	31	297	59	66		18	37	180	60.6
	Karatsu	57	19		12	88							
	Iki Channel	11	1	6		18							
Total	276	61	23	43	403								
Pacific Ocean	Cuesaki (Tosa)		2			2							
	Owashi (Kumano-Nada)	2				2							
	Ise Bay	24	11		11	46							
	Shimoda			2	5	7							
Total	26	13	2	16	57								
Total	4,392	3,017	663	2,534	10,617		3,237		525	692	4,459	42.3	

ENCLOSURE (I)

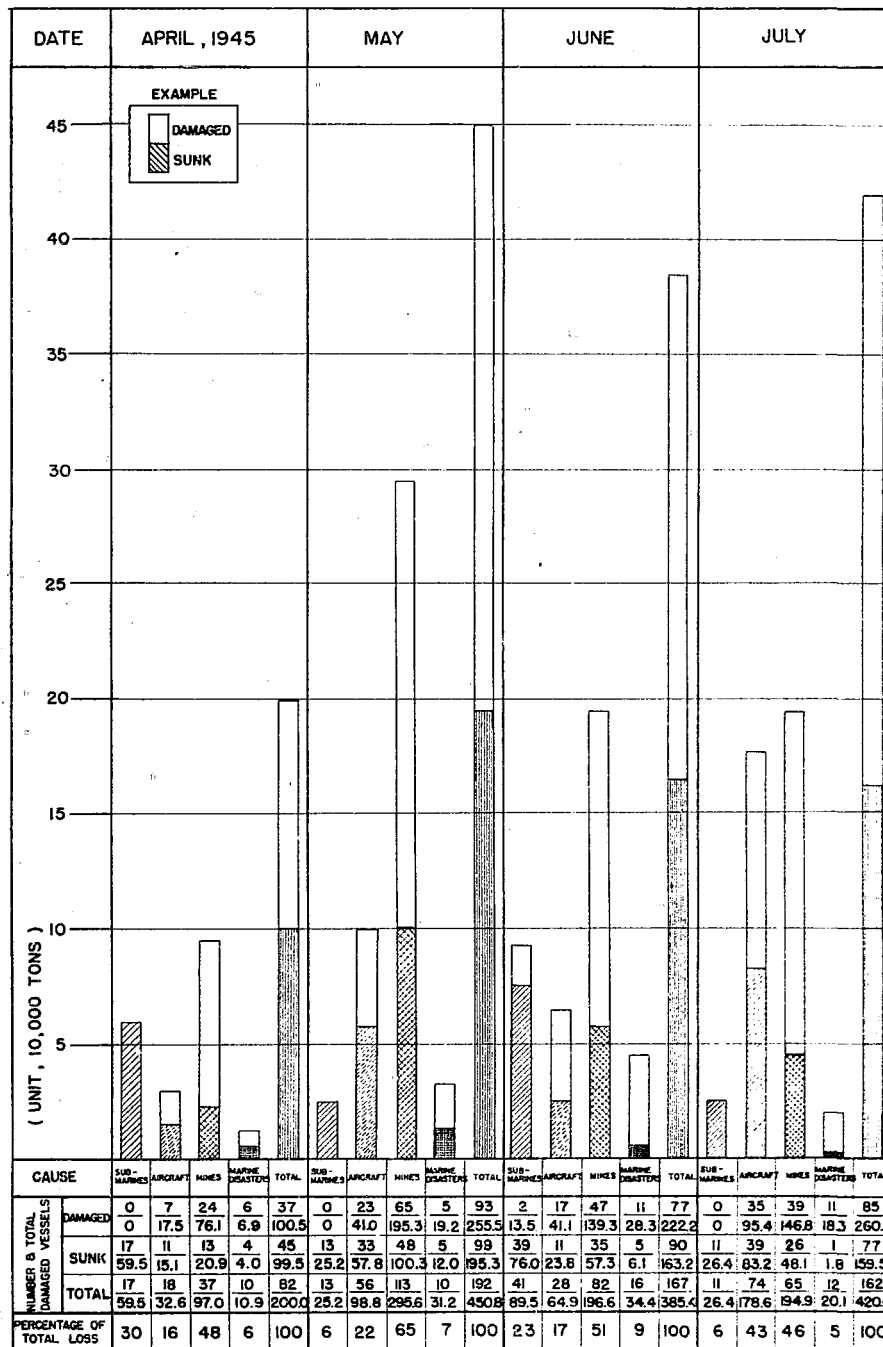

- 1 THE FRACTIONS DENOTE -  $\frac{\text{Number of Vessels}}{\text{Tons} \div 1000}$
- 2 VESSELS UNDER 500 TONS ARE NOT INCLUDED.
- 3 THE PERCENTAGE OF TOTAL LOSS IS BASED ON TONNAGE.

CHART SHOWING DAMAGE TO SHIPS CLASSIFIED ACCORDING TO CAUSE OF DAMAGE AS OF AUGUST 3, 1945

# ENCLOSURE (J)

RESTRICTED

INFORMATION CONCERNING MINES DETECTED BY THE MINE DETECTION GEAR (MARK RA)  
OF THE IMPERIAL JAPANESE ARMY AT SHIMONOSEKI

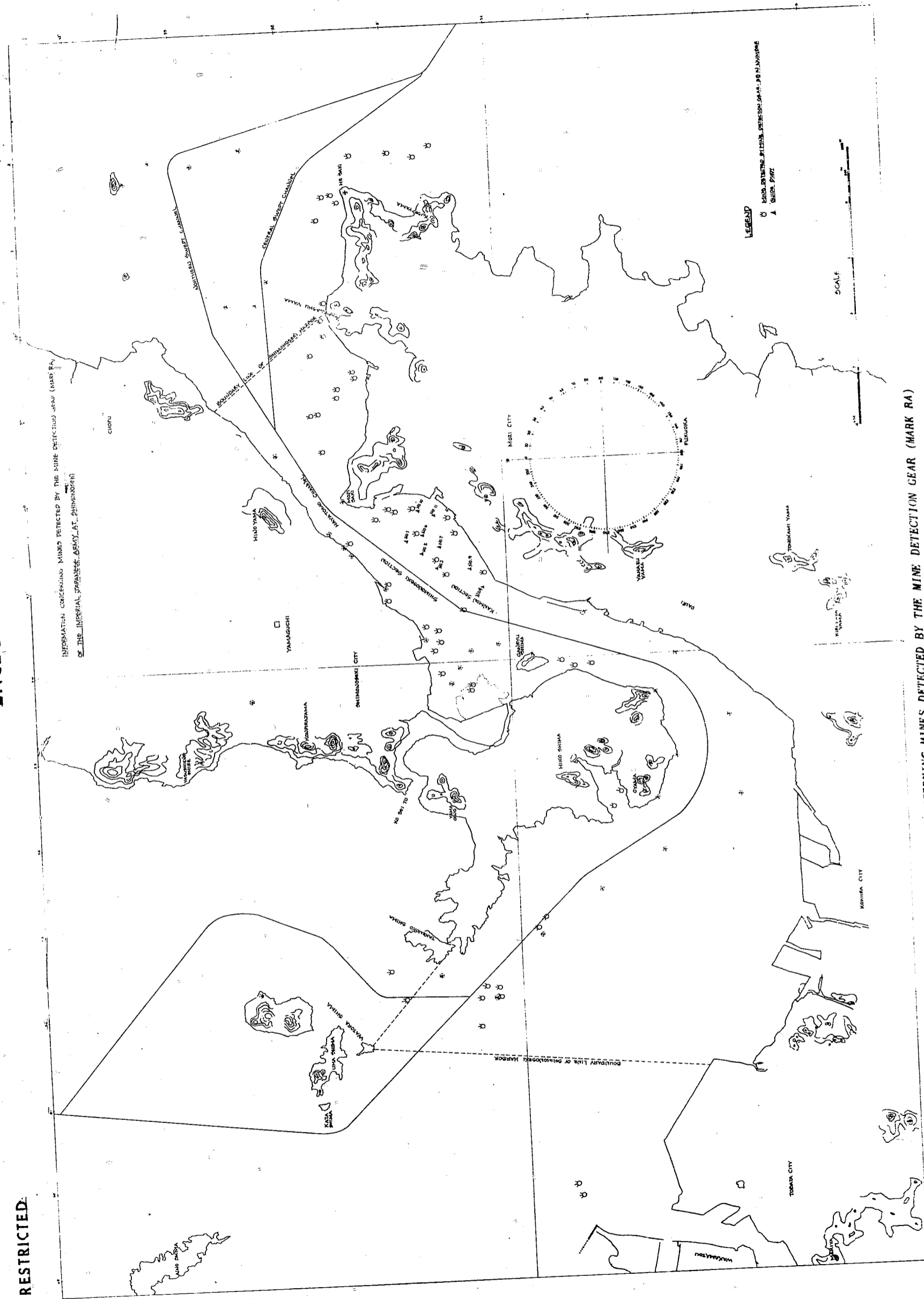

INFORMATION CONCERNING MINES DETECTED BY THE MINE DETECTION GEAR (MARK RA)  
OF THE IMPERIAL JAPANESE ARMY AT SHIMONOSEKI



## ENCLOSURE (K)

## LIST OF JAPANESE DOCUMENTS FORWARDED VIA ATIS TO VDC

<u>NavTechJap Document No.</u>	<u>ATIS No.</u>	<u>Title</u>
ND21-4562	3227	Handbook for Magnetic and Acoustic Mines and Sweeps, Parts 1 and 3.
ND50-5400	3279	Hydrographic Bulletin No. 14 (Location of Mines and Safety Channels).